



■ Features

- Constant Voltage PWM style output with user changeable frequency up to 4KHz compliant IEEE1789-2015 and EU Ecodesign SVM requirement
- Min. dimming level 0.01%
- Plastic housing with class II design
- Standby power consumption < 0.5W
- Integrated KNX control protocol
- No need KNX-DALI gateway
- Typical lifetime > 50000 hours
- 5 years warranty

■ Applications

- LED strip lighting
- Indoor LED lighting
- LED decorative lighting
- LED architecture lighting

■ GTIN CODE

MW Search: <https://www.meanwell.com/serviceGTIN.aspx>

■ Description

PWM KN series is a 120W AC/DC LED driver featuring the constant voltage mode with PWM style output, which is able to maintain the colour temperature and the brightness homogeneity when driving all kinds of LED strips and constant voltage LED bulbs. The built-in KNX interface is to avoid using the complicated KNX-DALI gateway.

PWM KN operates from 90~305VAC and offers two models with output voltage 12V & 24V. Thanks to the high efficiency up to 90%, with the fanless design, the entire series is able to operate for -40°C ~ +90°C case temperature under free air convection.

The minimal dimming level low to 0.01% is suitable for low light level applications e.g. cinema. The output frequency is changeable up to 4KHz complaint IEEE1789-2015 no risk requirement and EU Ecodesign stroboscopic visibility measure (SVM) requirement providing a great solution for health concern due to light flickering.

■ Model Encoding

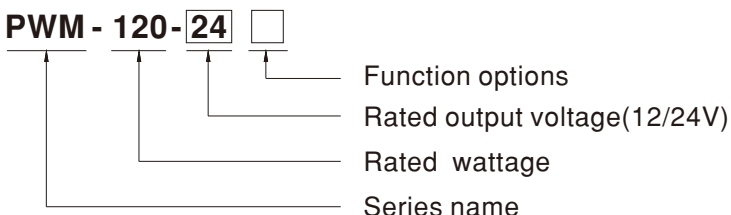

Type	Function	Note
KN	KNX control technology	In stock
KNBST	KNX control technology with BST14 connector	by request

SPECIFICATION

MODEL		PWM-120-12 □	PWM-120-24 □
OUTPUT	DC VOLTAGE	12V	24V
	RATED CURRENT	10A	5A
	RATED POWER	120W	120W
	DIMMING RANGE	0 ~ 100%	
	PWM FREQUENCY (Typ.)	200~4000Hz user changable via ETS	
	SETUP, RISE TIME <small>Note.2</small>	500ms, 80ms/ 230VAC or 115VAC	
	HOLD UP TIME (Typ.)	16ms/230VAC or 115VAC	
INPUT	VOLTAGE RANGE <small>Note.3</small>	90 ~ 305VAC 127 ~ 431VDC (Please refer to "STATIC CHARACTERISTIC" section)	
	FREQUENCY RANGE	47 ~ 63Hz	
	POWER FACTOR (Typ.)	PF>0.97/115VAC, PF>0.96/230VAC, PF>0.94/277VAC @ full load (Please refer to "POWER FACTOR (PF) CHARACTERISTIC" section)	
	TOTAL HARMONIC DISTORTION	THD< 20% (@load≥60%/115VAC, 230VAC; @load≥75%/277VAC) (Please refer to "TOTAL HARMONIC DISTORTION" section)	
	EFFICIENCY (Typ.)	88.5%	90%
	AC CURRENT (Typ.)	1.3A / 115VAC 0.65A / 230VAC 0.55A / 277VAC	
	INRUSH CURRENT (Typ.)	COLD START 60A(twidth=520μs measured at 50% Ipeak) at 230VAC; Per NEMA 410	
	MAX. NO. of PSUs on 16A CIRCUIT BREAKER	4 units (circuit breaker of type B) / 6 units (circuit breaker of type C) at 230VAC	
	LEAKAGE CURRENT	<0.25mA / 277VAC	
	STANDY POWER CONSUMPTION	<0.5W	
PROTECTION	OVERLOAD	108 ~ 130% rated output power Hiccup mode, recovers automatically after fault condition is removed	
	SHORT CIRCUIT	Shut down o/p voltage, re-power on to recover	
	OVER VOLTAGE	15 ~ 17V	28 ~ 34V
	OVER TEMPERATURE	Shut down o/p voltage, re-power on to recover	
ENVIRONMENT	WORKING TEMP.	Tcase=-40 ~ +90°C (Please refer to " OUTPUT LOAD vs TEMPERATURE" section)	
	MAX. CASE TEMP.	Tcase=+90°C	
	WORKING HUMIDITY	20 ~ 95% RH non-condensing	
	STORAGE TEMP., HUMIDITY	-40 ~ +80°C, 10 ~ 95% RH	
	TEMP. COEFFICIENT	±0.03%/°C (0 ~ 45°C, except 0 ~ 40°C for 12V)	
	VIBRATION	10 ~ 500Hz, 5G 12min./1cycle, period for 72min. each along X, Y, Z axes	
SAFETY & EMC	SAFETY STANDARDS <small>Note.5</small>	ENEC BS EN/EN61347-1, BS EN/EN61347-2-13, BS EN/EN62384 independent, GB19510.14,GB19510.1, EAC TP TC 004 approved	
	KNX STANDARDS	Certified protocol	
	WITHSTAND VOLTAGE	I/P-O/P:3.75KVAC	
	ISOLATION RESISTANCE	I/P-O/P:100M Ohms / 500VDC / 25°C / 70% RH	
	EMC EMISSION <small>Note.6</small>	Compliance to BS EN/EN55015, BS EN/EN61000-3-2 Class C (@load≥60%) ; BS EN/EN61000-3-3, GB/T 17743, GB17625.1;EAC TP TC 020	
	EMC IMMUNITY	Compliance to BS EN/EN61000-4-2,3,4,5,6,8,11; BS EN/EN61547, light industry level (surge immunity Line-Line 2KV),EAC TP TC 020	
OTHERS	MTBF	1915.2K hrs min. Telcordia SR-332 (Bellcore) ; 205.8K hrs min. MIL-HDBK-217F (25°C)	
	DIMENSION	191*63*37.5mm (L*W*H)	
	PACKING	0.80Kg; 15pcs/13.0Kg/0.87CUFT	
NOTE	<p>1. All parameters NOT specially mentioned are measured at 230VAC input, rated current and 25°C of ambient temperature.</p> <p>2. De-rating may be needed under low input voltages. Please refer to "STATIC CHARACTERISTIC" sections for details.</p> <p>3. Length of set up time is measured at first cold start. Turning ON/OFF the driver may lead to increase of the set up time.</p> <p>4. The driver is considered as a component that will be operated in combination with final equipment. Since EMC performance will be affected by the complete installation, the final equipment manufacturers must re-qualify EMC Directive on the complete installation again. (as available on https://www.meanwell.com/Upload/PDF/EMI_statement_en.pdf)</p> <p>5. This series meets the typical life expectancy of >50,000 hours of operation when Tcase, particularly (Tc) point (or TMP, per DLC), is about 75°C or less.</p> <p>6. Please refer to the warranty statement on MEAN WELL's website at http://www.meanwell.com</p> <p>7. The ambient temperature derating of 3.5°C/1000m with fanless models and of 5°C/1000m with fan models for operating altitude higher than 2000m(6500ft).</p> <p>8. For any application note and IP water proof function installation caution, please refer our user manual before using. https://www.meanwell.com/Upload/PDF/LED_EN.pdf</p> <p>※ Product Liability Disclaimer : For detailed information, please refer to https://www.meanwell.com/serviceDisclaimer.aspx</p>		

■ DIMMING OPERATION

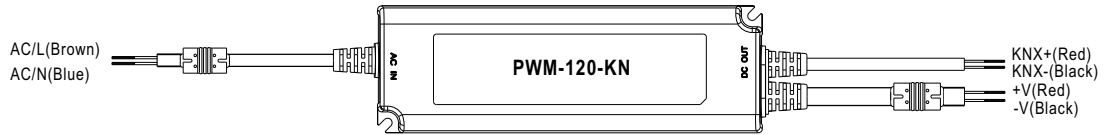

※ Dimming principle for PWM style output

Dimming is achieved by varying the duty cycle of the output current.

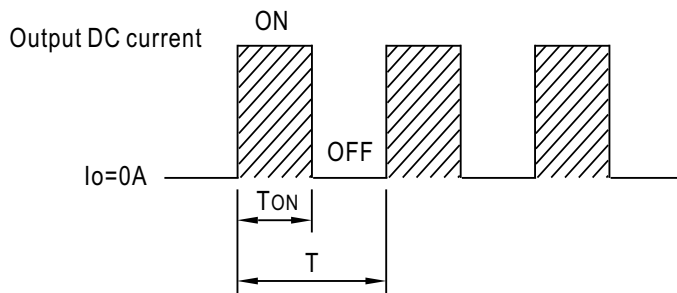

$$\text{Duty cycle(\%)} = \frac{T_{ON}}{T} \times 100\%$$

Output PWM frequency up to 4KHz

※ KNXInterface

- Apply KNX signal between KNX+ and KNX-.
- The application program(database) can be downloaded via Online Catalogs from ETS or via <http://www.meanwell.com/productCatalog.aspx>

OUTPUT LOAD vs TEMPERATURE

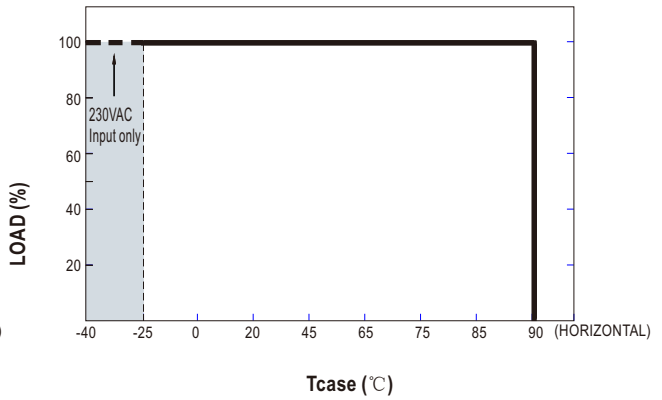
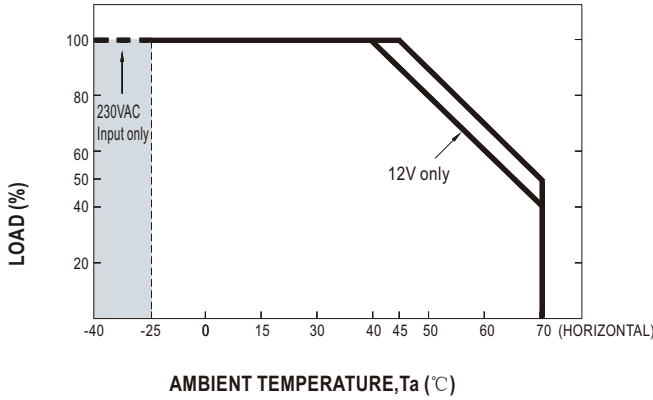

STATIC CHARACTERISTIC

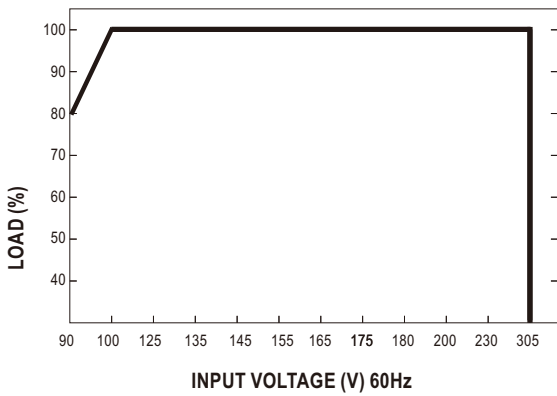

※ De-rating is needed under low input voltage.

POWER FACTOR (PF) CHARACTERISTIC

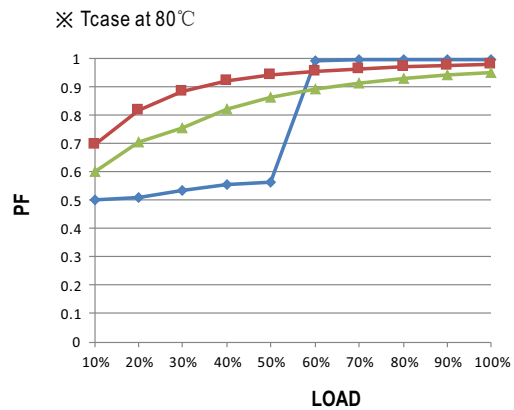

TOTAL HARMONIC DISTORTION (THD)

※ 24V Model, Tcase at 80°C

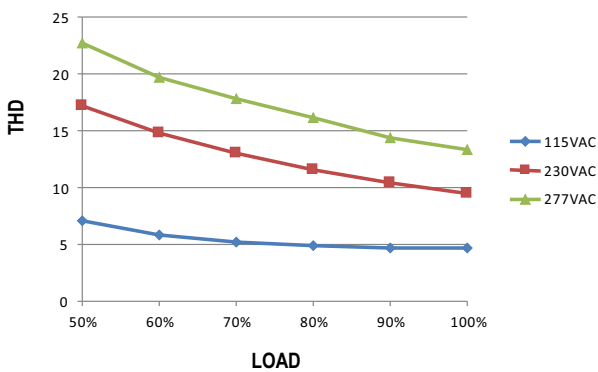

EFFICIENCY vs LOAD

PWM-120-KN series possess superior working efficiency that up to 90% can be reached in field applications.

※ 24V Model, Tcase at 80°C

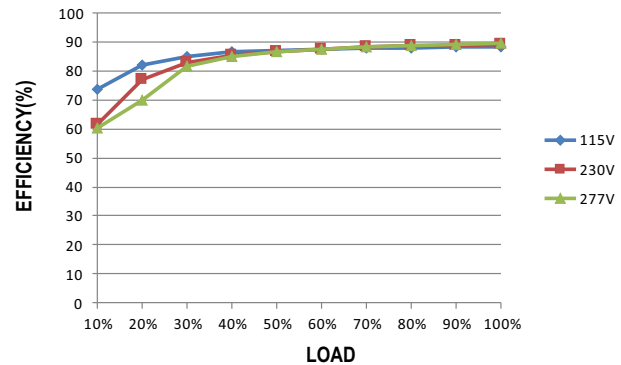

■ LIFE TIME

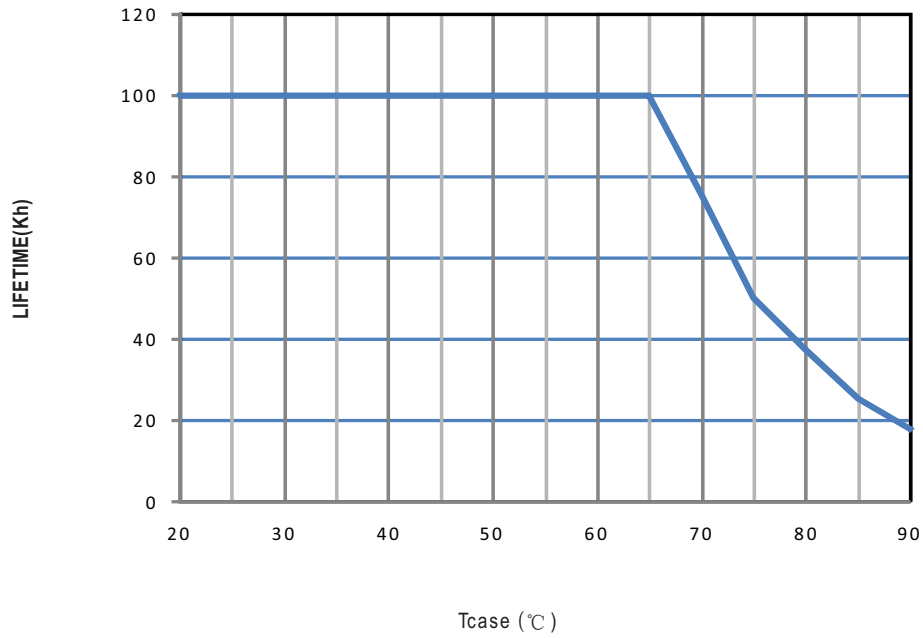

Block Diagram

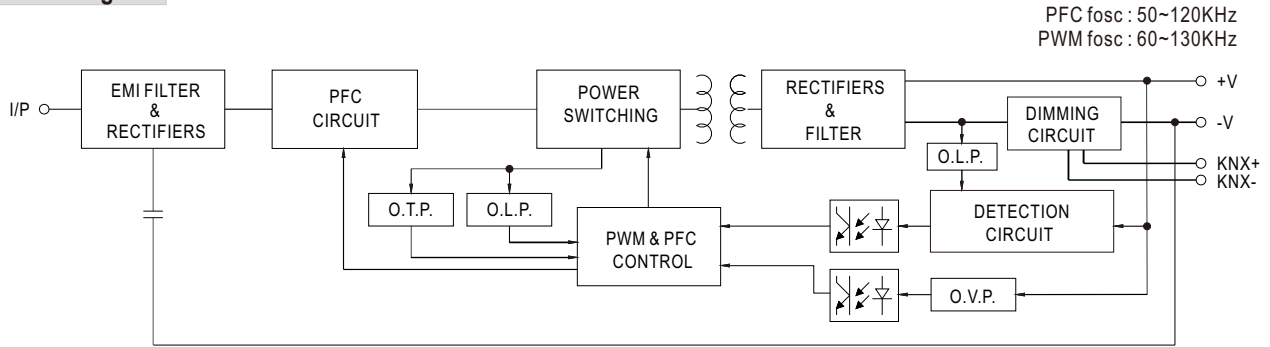

Note: PWM fosc here is not related to ouput PWM dimming

Mechanical Specification

Case No. PWM-120-KN Unit:mm

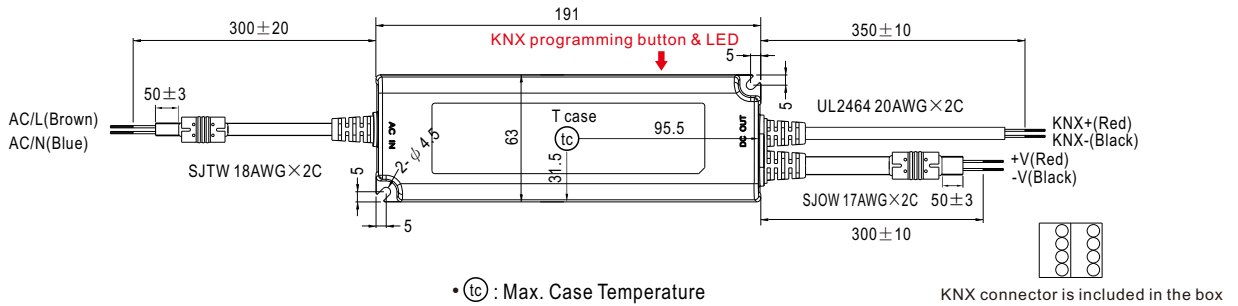

Mechanical view of by request

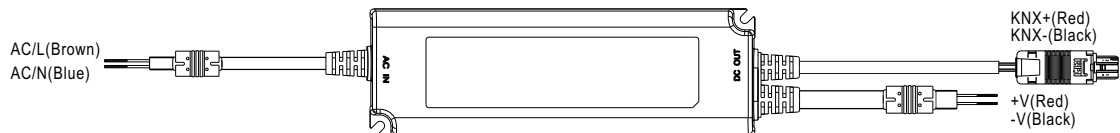

■ **Recommend Mounting Direction**

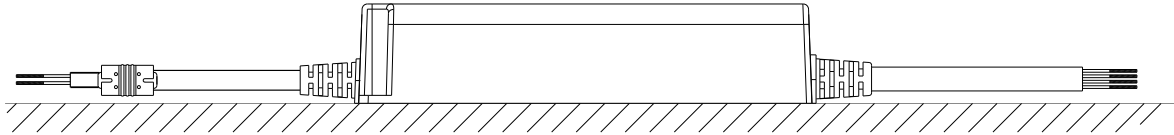

■ **Installation Manual**

◎ **Connection for KNX-type**

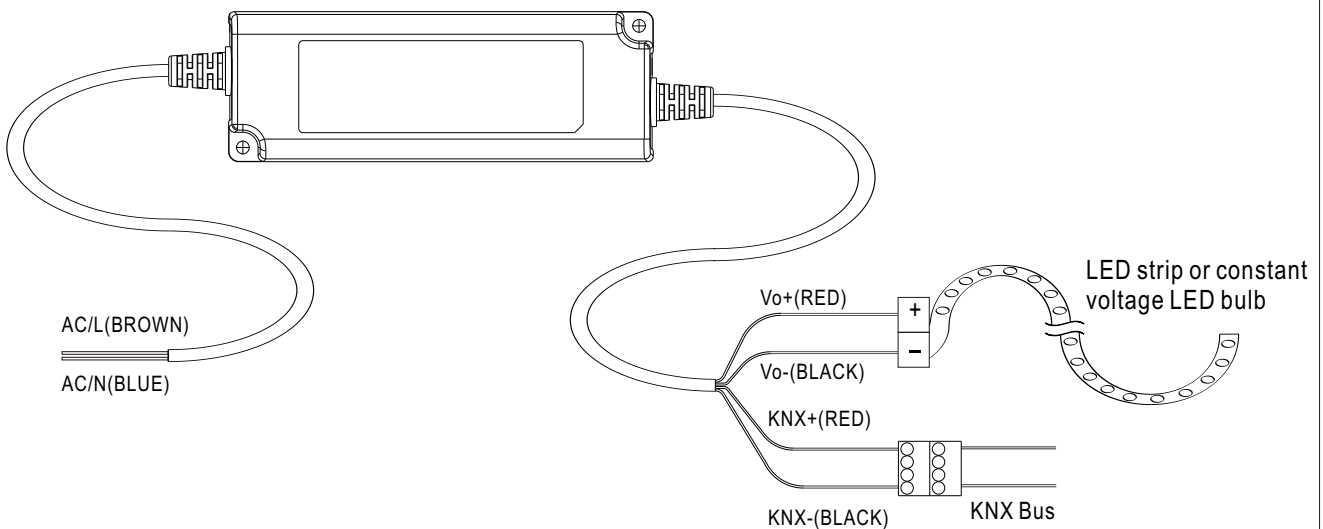

PWM KN series can be ETS addressing/programming WITHOUT connecting to AC mains

◎ **Cautions**

Before commencing any installation or maintenance work, please disconnect the power supply from the utility. Ensure that it cannot be re-connected inadvertently!

Keep proper ventilation around the unit and do not stack any object on it. Also a 10-15 cm clearance must be kept when the adjacent device is a heat source.

Mounting orientations other than standard orientation or operate under high ambient temperature may increase the internal component temperature and will require a de-rating in output current.

Current rating of an approved primary /secondary cable should be greater than or equal to that of the unit. Please refer to its specification.

Tc max. is identified on the product label. Please make sure that temperature of Tc point will not exceed limit.

DO NOT connect "KNX- to Vo-".

The power supply is considered as a component that will be operated in combination with final equipment. Since EMC performance will be affected by the complete installation, the final equipment manufacturers must re-qualify EMC Directive on the complete installation again.