



RKP-CMU1 / RKP-1U-CMU1 Instruction Manual

0.Safety Guidelines	1
1.Introduction of Series Models	1
1.1 Introduction.....	1
1.2 Features.....	1
1.3 Order Information.....	1
1.4 Main Specification.....	2
2.Mechanical Specification and Input/ Output Terminals	3
2.1 Mechanism of Single Unit.....	3
2.2 Mechanism of Whole Rack System.....	4
3.Functions	6
3.1 Rack Power Monitoring Functions.....	6
3.2 LED Indicators and LCD User Interface.....	6
3.3 Communication and Operation Interface.....	7
3.4 Real time clock, Data Log and Event Log.....	7
3.5 Programmable Relays and Digital Input Signals.....	7
3.6 Alarm.....	7
3.7 PMBus Communication Interface.....	8
3.8 Notes on PMBus Monitoring	10
3.9 Parallel Operation.....	10
3.10 Series Operation.....	12
4.RKP-CMU1 LCD User Interface	12
4.1 Description of RKP-CMU1 Front Panel.....	12
4.2 LCD Display.....	12
4.3 Status Menu.....	13
4.4 Setting.....	16
4.5 Maintenance Menu.....	19
4.6 Network Menu.....	20
5.RKP-CMU1 Web Page Monitoring Functions	21
5.1 IP settings of PC.....	21
5.2 Description of RKP-CUM1 Built-in Web Page.....	23
5.3 Event Log page.....	26
5.4 Data Log page.....	27
5.5 TCP/IP Configuration Page.....	27

6.RKP-CMU1 Monitoring Software.....	28
6.1 Installation.....	28
6.2 Using RS232 for Communication with RKP-CMU1.....	29
6.3 Description of RKP-CMU1 Monitoring Software.....	29
7.GSM Short Message Functions.....	36
7.1 Installation and Settings.....	36
7.2 Test of Sending a Short Message	37
7.3 AT-Command List for RKP-CMU1.....	37
8.Notes on Operation.....	38
8.1 Installation Method.....	38
8.2 De-rating.....	40
8.3 EMI Suppression Arrangement.....	40
8.4 Warranty.....	40



RKP-CMU1 / RKP-1U-CMU1 Instruction Manual

0. Safety Guidelines

- ⊙ Risk of electrical shock and energy hazard. All failure should be examined by a qualified technician. Please do not remove the case from the unit.
- ⊙ Please do not change any component on the unit by yourself or make any kind of modification on it.
- ⊙ Please do not install the unit in places with high moisture, high ambient temperature or under direct sunlight.
- ⊙ Please do not feed in voltage that is over or less than 10% of the rated value. Refer to the safety label on the unit.
- ⊙ The safety protection level of this unit is class I. As a result, the "Frame Ground" (≠) on the rear of the rack unit must be well connected to earth ground. The total leakage current of the whole system, including two RCP-2000 units, is less than 2.3mA.

1. Introduction of Series Models

1.1 Introduction

The RKP-CMU1 is a dedicated monitor unit for Rack Power series with PMBus interface. It provides the management task of RCP-2000 for using in telecommunication, monitoring systems, servers, etc. It can be stand-alone operated or integrated into a 19-inch rack.

1.2 Features

- ⊙ 1U low profile/19-inch rack mounting.
- ⊙ Control and monitor rack power units.
- ⊙ Front panel LCD and buttons for on-site service without PC.
- ⊙ USB, RS-232, or Ethernet interface for PC connection locally or remote monitoring and control via GSM modem.
- ⊙ Alarm/event log with time and date.
- ⊙ Windows-based PC communication software.
- ⊙ Easy wire connections on rear side.
- ⊙ 4 user programmable relay outputs for traditional remote monitoring or warning.
- ⊙ 3 years warranty.

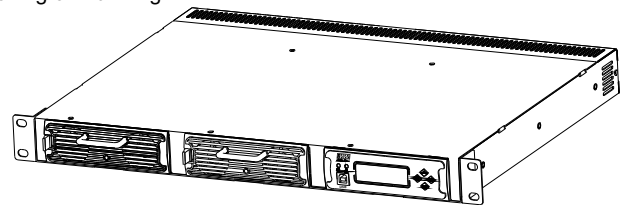

1.3 Order Information

1.3.1 Explanation for Encoding

Single unit : RKP-CMU1

1U rack : RKP-1U I -CMU1

I : IEC320-C20 AC Inlet
T : Terminal Block

Whole system (2*RCP-2000 + 1*RKP-CMU1 + RKP-1U I):

RKP-6K1U I - CMU1 - 12

Output Voltage
I : IEC320-C20 AC Inlet
T : Terminal Block

1.3.2 Marking

- ⊙ Please refer to the safety label on top of each unit before operating (Figure 1-1~1-3).
- ⊙ Single unit :

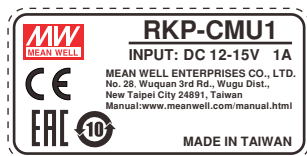

Figure 1-1 Safety Label of RKP-CMU1

1.3.3 Model of Rack Powers supported by RKP-CMU1

Please pay attentions when choosing rack power! RKP-CMU1 with new and old firmware revisions supports a variety of PSU models with specific firmware revisions as shown in table below.

RKP-CMU1 Firmware Revision	PSU Model and Firmware Revision
R2.0	DRP-3200,R1.0 and later
	RCP-1600,R2.0 and later
	RCP-2000,R2.0 and later
R1.1	RCP-2000,R1.9 and prior

⊙Rack :

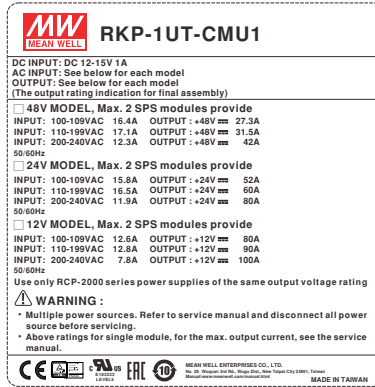
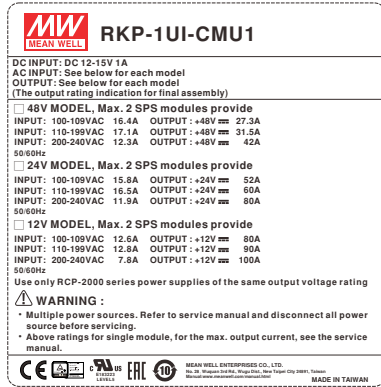

Figure1-2: Safety Labels of RKP-1U□-CMU1

⊙Whole system (2*RCP-2000 + 1*RKP-CMU1 + RKP-1U□) :

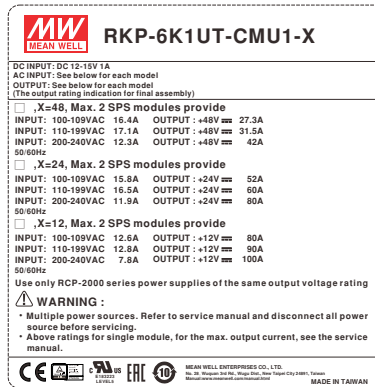
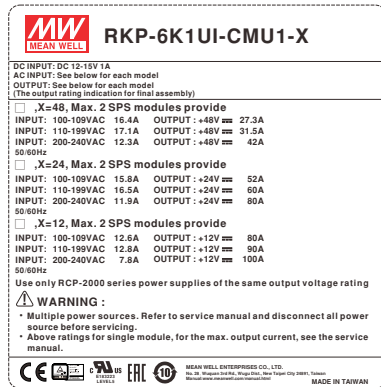

Figure 1-3: Safety Labels of RKP-6K1U-CMU1 Series

1.4 Main Specification

MODEL		RKP-CMU1	RKP-1U□-CMU1
OUTPUT	DIGITAL METER	Note.6	Display the DC output voltage, current, and internal temperature
	CONTROL OUTPUT	Note.6	PMBus signal
	LED INDICATOR		Green: Power on Red:Alarm
	RELAY CONTACT		4 user programmable relay, relay contact rating(max.): 30V/1A resistive
INPUT	VOLTAGE RANGE	Note.3	12 ~ 15VDC
	CURRENT		1A/12VDC 0.8A/15VDC
	MONITORING INPUTS	Note.6	PMBus signal
FUNCTION	DISPLAY		LCD 16x2 Alphanumeric Matrix Display / PC Web Page Display
	MONITOR		Output Voltage / Load Current / Temperature / Input Voltage
	CONTROL		Output Voltage, Current Limit, ON/OFF
	COMM. INTERFACE		USB, RS-232, Ethernet
	MODEL SUPPORTED		RCP-1600, RCP-2000, DRP-3200 RCP-2000
ENVIRONMENT	WORKING TEMP.	Note.1	-25 ~ +70°C
	WORKING HUMIDITY		20 ~ 90% RH non-condensing
	STORAGE TEMP., HUMIDITY		-40 ~ +85°C, 10 ~ 95% RH non-condensing
	VIBRATION		10 ~ 500Hz, 2G 10min./1cycle, 60min. each along X, Y, Z axes
SAFETY & EMC (Note 4)	SAFETY STANDARDS		EAC TP TC 004 approved, design refer to TUV EN60950-1 UL60950-1, TUV EN60950-1, EAC TP TC 004 approved
	WITHSTAND VOLTAGE	Note.2	O/P-FG:0.7KVDC I/P-O/P:3KVAC I/P-FG:2KVAC O/P-FG:0.7KVDC
	ISOLATION RESISTANCE	Note.2	O/P-FG:100M Ohms / 500VDC / 25°C / 70% RH I/P-O/P, I/P-FG,O/P-FG:100M Ohms / 500VDC / 25°C / 70% RH
	EMC EMISSION		Compliance to EN55032 (CISPR32) Conduction Class B, Radiation Class A ; EN61000-3-2,-3, EAC TP TC 020
	EMC IMMUNITY		Compliance to EN61000-4-2,3,4,5,6,8,11, EN61000-6-1(EN50082-2), light industry level, criteria A, EAC TP TC 020
OTHERS	MTBF		110.5K hrs min. MIL-HDBK-217F (25°C)
	DIMENSION		147.5*127*41mm (L*W*H) 486.6*350.8*44mm (L*W*H)
	PACKING		0.8Kg; 16pcs/13.8Kg/0.79CUFT 4.4Kg; 3pcs/14.2Kg/2.67CUFT
NOTE	<p>1. LCD may freeze under -10°C.</p> <p>2. SK100 and all of signal connectors (except CN502, CN503, and USB port) are considered as O/P.</p> <p>3. Recommended use MEAN WELL power adaptor series: GS12, GS15, GS18, GE12, GE18, GST18.</p> <p>4. The power supply is considered a component which will be installed into a final equipment. All the EMC tests are been executed by mounting the unit on a 720mm*360mm metal plate with 1mm of thickness. The final equipment must be re-confirmed that it still meets EMC directives. For guidance on how to perform these EMC tests, please refer to "EMI testing of component power supplies." (as available on https://www.meanwell.com/Upload/PDF/EMI_statement_en.pdf)</p> <p>5. The ambient temperature derating of 3.5°C/1000m with fanless models and of 5°C/1000m with fan models for operating altitude higher than 2000m(6500ft).</p> <p>6. Please refer to respective specs of PSU models for the maximum number RKP-CMU1 can control and monitor.</p> <p>※ Product Liability Disclaimer : For detailed information, please refer to https://www.meanwell.com/serviceDisclaimer.aspx</p>		

2.Mechanical Specification and Input/ Output Terminals

2.1 Mechanism of Single Unit

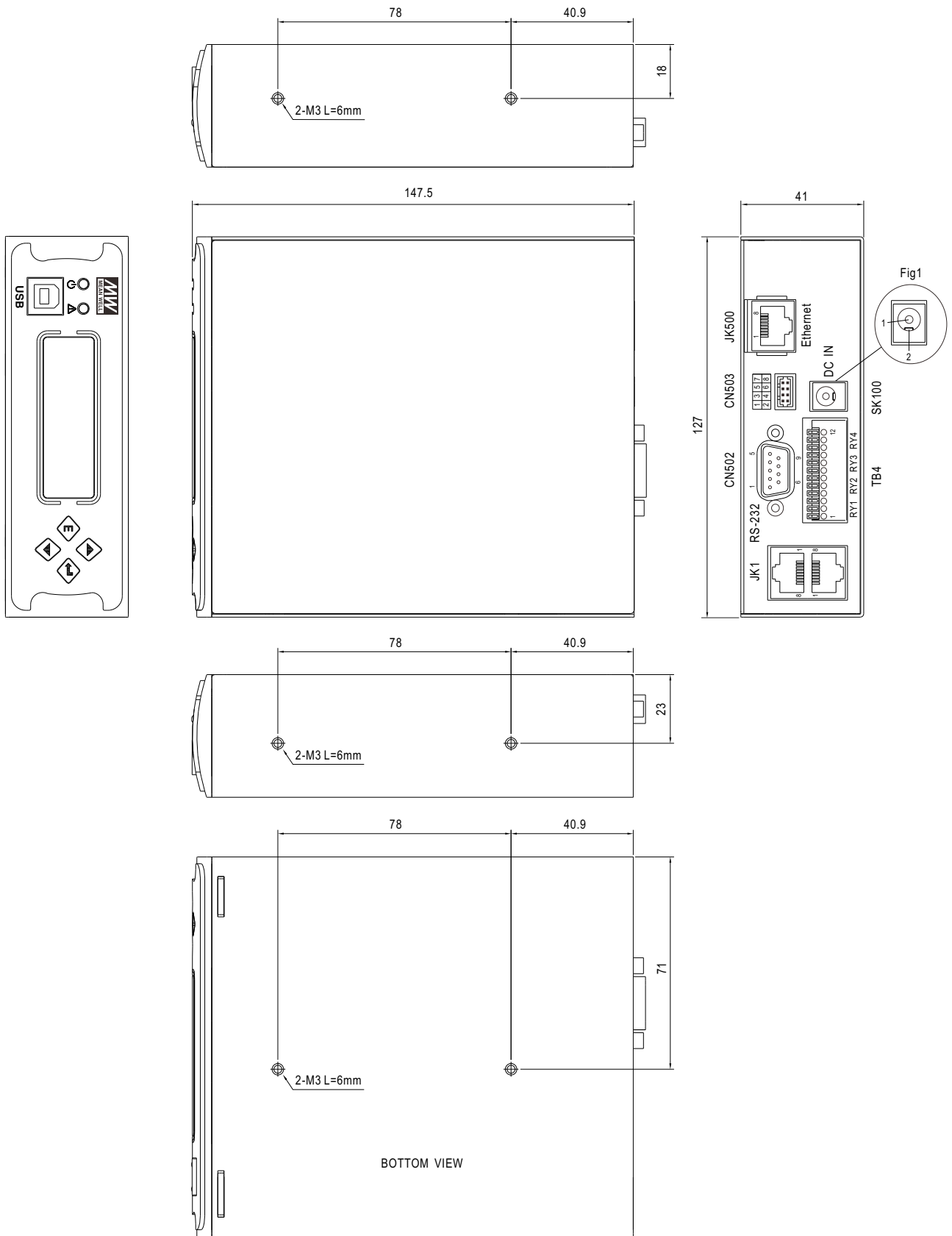

Figure 2-1

2.2 Mechanism of Whole Rack System

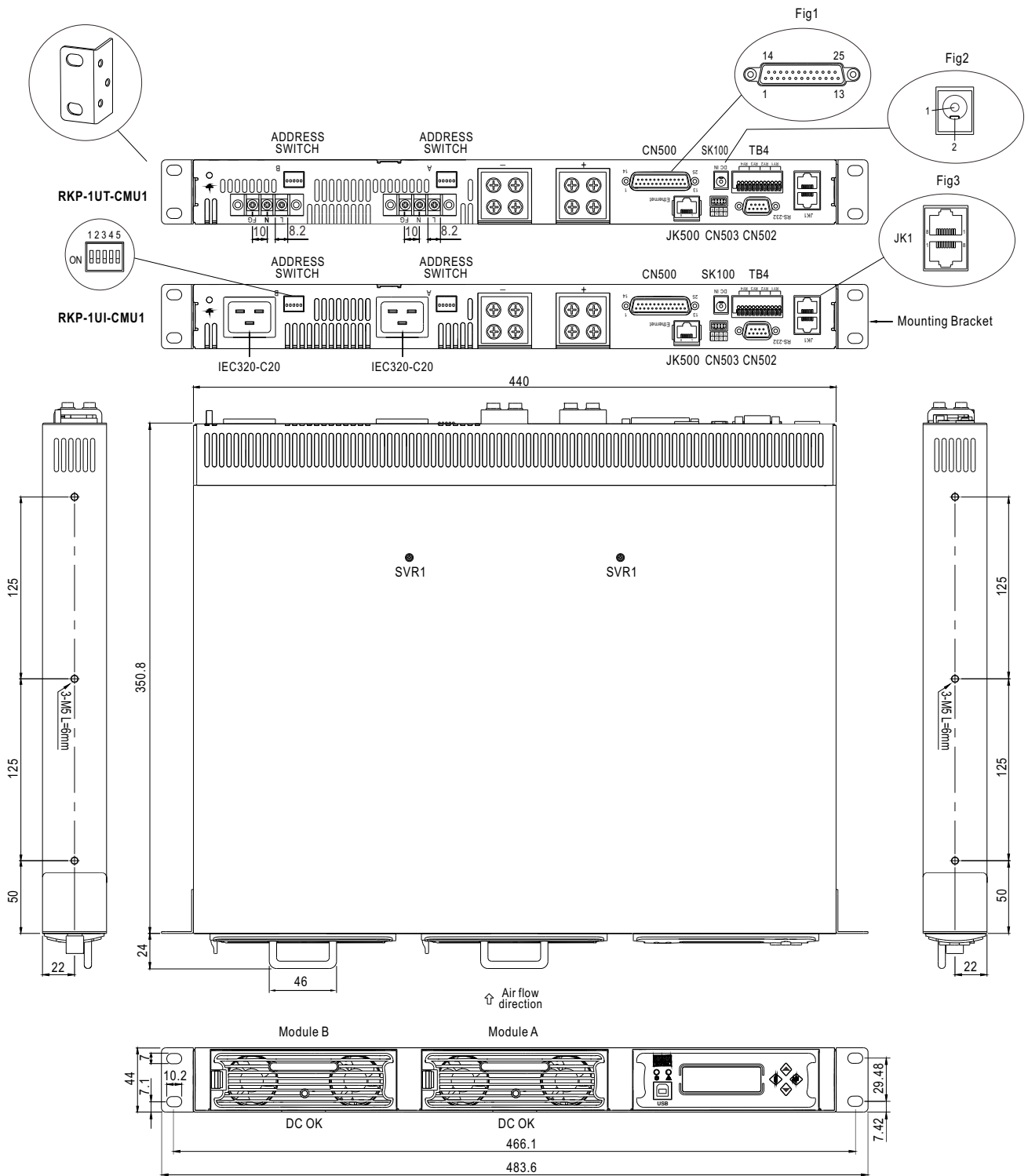

Figure 2-2

©CN500 Pin No. Assignment

Connector Pin No. Assignment(CN500) : D-Type Right Angle 25 positions

Pin No.	Assignment	Pin No.	Assignment	Pin No.	Assignment	Pin No.	Assignment
1	ON/OFF-A	6	FAN FAIL-A	11	T-ALARM-B	16~21	N.C.
2	AC-OK-A	7	ON/OFF-B	12	FAN FAIL-B	22	+S
3	DC-OK-A	8	AC-OK-B	13	+5V-AUX	23	-S
4	PV-A	9	DC-OK-B	14	+12V-AUX	24	+V
5	T-ALARM-A	10	PV-B	15	GND-AUX	25	-V

◎JK1 Pin No. Assignment

Connector Pin No. Assignment(JK1) : RJ45 8 positions

Pin No.	Assignment	Pin No.	Assignment	Pin No.	Assignment
1	DA	4	CONTROL	7	SCL
2	DB	5	NC	8	GND-AUX
3	-V	6	SDA		

◎CN502 Pin No. Assignment

Connector Pin No. Assignment(CN502) : D-type Male 9 positions

Pin No.	Assignment	Pin No.	Assignment
1,4,6,7,8,9	NC	3	TXD
2	RXD	5	GND-FG

◎CN503 Pin No. Assignment

Connector Pin No. Assignment(CN503) : HRS DF11-8DP-2DS or equivalent

Pin No.	Assignment	Pin No.	Assignment
1	D-IN1	5	D-IN3
2,4,6,8	GND-FG	7	D-IN4
3	D-IN2		

◎JK500 Pin No. Assignment

Connector Pin No. Assignment(JK500) : RJ45 8 position

Pin No.	Assignment	Pin No.	Assignment
1	TX+	4,5,7,8	NC
2	TX-	6	RX-
3	RX+		

◎TB4 Pin No. Assignment : Connector Pin No. Assignment(TB4)

DECA MX422-25412 or equivalent

Pin No.	Assignment	Pin No.	Assignment	Pin No.	Assignment	Pin No.	Assignment
1	Relay1-NO	4	Relay2-NO	7	Relay3-NO	10	Relay4-NO
2	Relay1-NC	5	Relay2-NC	8	Relay3-NC	11	Relay4-NC
3	Relay1-COM	6	Relay2-COM	9	Relay3-COM	12	Relay4-COM

◎SK100 Pin No. Assignment : Connector Pin No. Assignment(SK100)

Schurter 4840.2201 or equivalent

Pin No.	Assignment	Pin No.	Assignment
1	+VIN	2	-VIN

◎Description of CN500 connection pins

Pin No.	Function	Description
1,7	ON/OFF	Each unit can separately turn the output on and off by electrical signal or dry contact between ON/OFF A,B(pin 1,7) and +5V-AUX (pin 13). Short: ON, Open: OFF. (Note.2)
2,8	AC-OK	Low : When the input voltage is ≥ 87 Vrms. High : when the input voltage is ≤ 75 Vrms. (Note.2)
3,9	DC-OK	High : When the Vout is $\leq 80\pm 5\%$. Low : When the Vout is $\geq 80\pm 5\%$ (Note.2)
4,10	PV	Connection for output voltage trimming. The voltage can be trimmed within its defined range. (Note.1)
5,11	T-ALARM	High : When the internal temperature (TSW1 or TSW2 open) exceeds the limit of temperature alarm. Low : When the internal temperature (TSW1 or TSW2 short) is under the limit temperature. (Note.2)
6,12	FAN FAIL	High : When the internal fan is failure. Low : When the internal fan is normal operating. (Note.2)
13	+5V-AUX	Auxiliary voltage output, 4.3~5.5V, referenced to GND-AUX (pin 15). The maximum load current is 0.3A. This output has the built-in "Oring diodes" and is not controlled by the remote ON/OFF control.
14	+12V-AUX	Auxiliary voltage output, 10.8~13.2V, referenced to GND-AUX (pin 15). The maximum load current is 0.8A. This output has the built-in "Oring diodes" and is not controlled by the remote ON/OFF control.
15	GND-AUX	Auxiliary voltage output GND. The signal return is isolated from the output terminals (+V & -V).
16~21	NC	Not used.
22	+S	Positive sensing. The +S signal should be connected to the positive terminal of the load. The +S and -S leads should be twisted in pair to minimize noise pick-up effect. The maximum line drop compensation is 0.5V.
23	-S	Negative sensing. The -S signal should be connected to the negative terminal of the load. The -S and +S leads should be twisted in pair to minimize noise pick-up effect. The maximum line drop compensation is 0.5V.
24	+V	Positive output voltage. For local sense use only, cannot be connected directly to the load.
25	-V	Negative output voltage. For local sense use only, cannot be connected directly to the load.

◎Description of JK1 connection pins

Pin No.	Function	Description
1,2	DA,DB	Differential digital signal for parallel control. (Note.1)
3	-V	Negative output voltage. For parallel control, can't be connected directly to the load.
4	CONTROL	Remote ON/OFF control pin used in the PMBus interface. (Note.2)
5	NC	Not used.
6	SDA	Serial Data used in the PMBus interface. (Note.2)
7	SCL	Serial Clock used in the PMBus interface. (Note.2)
8	GND-AUX	Auxiliary voltage output GND. The signal return is isolated from the output terminals (+V & -V).

Note.1: Non-isolated signal, referenced to the output terminals (-V).

Note.2: Isolated signal, referenced to GND-AUX.

◎Description of CN502 connection pins

Pin No.	Function	Description
1,4,6,7,8,9	NC	Not used.
2	RXD	Data receiving pin of RS-232 interface.
3	TXD	Data transmitting pin of RS-232 interface.
5	GND-FG	RS-232 common GND. This signal connects to FG and isolated from -V and GND-AUX.

◎Description of CN503 connection pins

Pin No.	Function	Description
1,3,5,6	D-IN1 D-IN2 D-IN3 D-IN4	The isolated digital input signal and referenced to GND-FG (pin2, 4, 6, 8). Open from GND-FG or +5V : Logic "1" input to RKP-CMU1 short to GND-FG or 0V : Logic "0" input to RKP-CMU1
2,4,6,8	GND-FG	Common GND for D-IN. This signal connects to FG and isolated from -V and GND-AUX.

◎Description of JK500 connection pins

Pin No.	Function	Description
1,2	TX+/TX-	Data transmitting pin of the Ethernet interface.
3,6	RX+/RX-	Data receiving pin of the Ethernet interface.
4,5,7,8	NC	Not used.

◎Description of TB4 connection pins

Pin No.	Function	Description
1,4,7,10	Relay-NO	Normal-open contact of programmable relay.
2,5,8,11	Relay-NC	Normal-close contact of programmable relay.
3,6,9,12	Relay-COM	Common for NO/NC contact.

Note: Relay contact rating (max.): 30Vdc/1A resistive.

◎Description of SK100 connection pins

Pin No.	Function	Description
1	+VIN	Positive input voltage for RKP-CMU1.
2	-VIN	Negative input voltage for RKP-CMU1.

⚠ CAUTION :

Please use adequate force to insert the RCP-2000 into the RKP-1U-CMU1.

Slamming power supplies into the rack can damage the connectors both on the rear of the supplies and inside the rack.

3.Functions

3.1 Rack power monitoring functions

As a power management device. It not only can read the operating parameters or data (such as output voltage, output current, internal temperature, working status, series number, and firmware version) from the units, but also can be used to adjust the values of bus voltage and PSU current. In addition, it can remotely turn the Rack Power units on/off by the command of "PMBus OPERATION" (pin6,7 JK1).

It is also possible to remotely control the Rack Power units without using the RKP-CMU1 by connecting the physical pins of "PMBus CONTROL" (pin4 JK1) or "RKP-1U ON/OFF" (pin1,7 CN500) to +5V-AUX. Please refer to Table 3-1.

RKP-1U ON/OFF pin	PMBus CONTROL pin	PMBus OPERATION Command	RCP-2000 output state
Connect to +5V-AUX	Open	80h (ON)	ON
Connect to +5V-AUX	Connect to +5V-AUX	80h (ON)	ON
Open	Open	80h (ON)	OFF
Open	Connect to +5V-AUX	80h (ON)	ON
Don't care	Don't care	00h (OFF)	OFF

Table 3-1

Note: If the purchased unit is a rack or whole system unit, the RKP-CMU1 is internally connected with JK1 (including pin 4 of "PMBus CONTROL" and pin 6,7 of "PMBus OPERATION"), which means it can directly remote-control the Rack Power units in the rack. So, when you are using the unit as a power management device to monitor your system, the pins of CN500 for "RKP-1U ON/OFF" must be opened from +5V-AUX to avoid interfering in RKP-CMU1's proper operation.

3.2 LED Indicators and LCD User Interface

There are LED indicators on the front panel of the RKP-CMU1 that are used to display system operating status. Refer to Table 3-2 for details.



LED	Status	Description
	Green	Power on indicator of RKP-CMU1. It will be green while normal operation.
	Flashing red	RKP-CMU1 or Rack Power is under an abnormal situation.
	No indication	Normal condition.

Table 3-2

Besides that, there are also a LCD screen and control buttons on the front panel, the LCD user interface. It can be used to monitor, manage, and control your system without using other equipment. Refer to chapter 4 for details.

3.3 Communication and Operation Interface

The RKP-CMU1 uses PMBus as the communication interface to communicate with RCP-2000 units to monitor, manage, and control these units.

The RKP-CMU1 can link to a PC (personal computer) via USB, RS232, or Ethernet, and through the operation interface at the PC side (like monitoring software or Microsoft Internet Explorer), management of the rack power can be consolidated at the PC side as shown in Figure 3-1. Details will be described in the following chapters.



Figure 3-1 Diagram of the communication interface of the RKP-CMU1

3.4 Real Time Clock, Data Log and Event Log

The RKP-CMU1 has a built-in real time clock to display actual date/time for log timestamp. The Data Log is used to store the operating data of the rack power system. It has 1000 records and the interval of log is programmable from 1 to 60 minutes. The Event Log is designed to store abnormal system condition when an alarm occurs and removes. There are up to 600 records of Event Log that can be stored in the RKP-CMU1.

3.5 Programmable Relays and Digital Input Signals

To fulfill the requirements of industrial applications for the rack power system, the RKP-CMU1 offers 4 digital input signals in CN503 and 4 programmable relays in TB4. In addition, these relays provide both normally-open (N.O.) and normally-closed (N.C.) operations for selection. The operating conditions of the relays are shown in Table 3-3.

Functions	Selections
Alarm	1.Any alarm 2.OVP 3.OLP 4.Short circuit 5.OTP 6.High temp. 7.AC fail 8.Fan lock 9.PMBus Error
PSU ON	1.Immediately 2.Delay 1 ~ 600 sec
PSU OFF	1.Immediately 2.Delay 1 ~ 600 sec
Digital Input	Control by Digital input 1 ~ 4

Table 3-3

3.6 Alarm

When an abnormal situation occurs, the red LED indicator on the front panel will flash. The abnormal situation detected can be interpreted on the LCD screen or your computer. Abnormal situations and the descriptions are shown as below.

	Status	Description
Rack Power's abnormal situations	OVP	Over voltage protection
	OLP	Overload protection
	Short circuit	Output short circuit protection
	OTP	Over temperature protection
	High temp.	Internal over temperature alarm
	AC fail	Low AC power shutdown
	Fan lock	Fan malfunction protection

Table 3-4

3.7 PMBus Communication Interface

The RKP-CMU1 is equipped with all the PMBus commands that Rack Power needs. This makes it easy for users to monitor, manage, and control their Rack Power systems by means of the LCD user interface or the Windows based user interface. Moreover, the unit is compliant with PMBus Rev. 1.1 (the maximum communication speed is 100 KHz) and has the capability of identifying up to 9 addressed units of RCP-2000.

3.7.1 PMBus Device Addressing

Each Rack Power unit should have their unique and own device address to communicate over the PMbus. Ex:7-bit address setting pins are used to assign a device address for a RCP-2000 unit, as the description shows below .

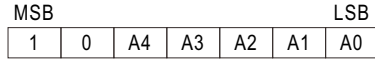

A0~A4, five of the bits, can be set via a 5-pole DIP switch on the rear panel of a rack unit. The "ON" position represents logic "0" while the "OFF" position represents logic "1".

There are 32 different addresses available to be assigned by the DIP switch. The switch settings show as below.



Module No.	DIP switch position				
	1	2	3	4	5
0	ON	ON	ON	ON	ON
1	OFF	ON	ON	ON	ON
2	ON	OFF	ON	ON	ON
3	OFF	OFF	ON	ON	ON
4	ON	ON	OFF	ON	ON
5	OFF	ON	OFF	ON	ON
6	ON	OFF	OFF	ON	ON
7	OFF	OFF	OFF	ON	ON
8	ON	ON	ON	OFF	ON
9	OFF	ON	ON	OFF	ON
10	ON	OFF	ON	OFF	ON
11	OFF	OFF	ON	OFF	ON
12	ON	ON	OFF	OFF	ON
13	OFF	ON	OFF	OFF	ON
14	ON	OFF	OFF	OFF	ON
15	OFF	OFF	OFF	OFF	ON

Module No.	DIP switch position				
	1	2	3	4	5
16	ON	ON	ON	ON	OFF
17	OFF	ON	ON	ON	OFF
18	ON	OFF	ON	ON	OFF
19	OFF	OFF	ON	ON	OFF
20	ON	ON	OFF	ON	OFF
21	OFF	ON	OFF	ON	OFF
22	ON	OFF	OFF	ON	OFF
23	OFF	OFF	OFF	ON	OFF
24	ON	ON	ON	OFF	OFF
25	OFF	ON	ON	OFF	OFF
26	ON	OFF	ON	OFF	OFF
27	OFF	OFF	ON	OFF	OFF
28	ON	ON	OFF	OFF	OFF
29	OFF	ON	OFF	OFF	OFF
30	ON	OFF	OFF	OFF	OFF
31	OFF	OFF	OFF	OFF	OFF

Table 3-5

3.7.2 PMBus Command List

Table 3-6 shows the command list of PMBus. It is compliant with the standard protocol of PMBus Rev. 1.1. For more detailed information, please refer to PMBus official website (<http://pmbus.org/specs.html>).

Command Code	Command Name	Transaction Type	# of data Bytes	Description
01h	OPERATION	R/W Byte	1	Remote ON/OFF control
02h	ON_OFF_CONFIG	Read Byte	1	ON/OFF function configuration
19h	CAPABILITY	Read Byte	1	Capabilities of a PMBus device
20h	VOUT_MODE	R Byte	1	Define data format for output voltage (format: Rack power user's manual)
21h	VOUT_COMMAND	R Word	2	Output voltage setting value (format: Rack power user's manual)
22h	VOUT_TRIM	R/W Word	2	Output voltage trimming value (format: Rack power user's manual)
46h	IOUT_OC_FAULT_LIMIT	R/W Word	2	Output overcurrent setting value (format: Rack power user's manual)
47h	IOUT_OC_FAULT_RESPONSE	R Byte	1	Define protection and response when an output overcurrent fault occurred
79h	STATUS_WORD	R Word	2	Summary status reporting
7Ah	STATUS_VOUT	R Byte	1	Output voltage status reporting

Command Code	Command Name	Transaction Type	# of data Bytes	Description
7Bh	STATUS_IOUT	R Byte	1	Output current status reporting
7Ch	STATUS_INPUT	R Byte	1	AC input voltage status reporting
7Dh	STATUS_TEMPERATURE	R Byte	1	Temperature status reporting
80h	STATUS_MFR_SPECIFIC	R Byte	1	Manufacture specific status reporting
81h	STATUS_FANS_1_2	R Byte	1	Fan1 and 2 status reporting
88h	READ_VIN	R Word	2	AC input voltage reading value (format: Rack power user's manual)
8Bh	READ_VOUT	R Word	2	Output voltage reading value (format: Rack power user's manual)
8Ch	READ_IOUT	R Word	2	Output current reading value (format: Rack power user's manual)
8Dh	READ_TEMPERATURE_1	R Word	2	Temperature 1 reading value (format: Rack power user's manual)
90h	READ_FAN_SPEED_1	R Word	2	Fan speed 1 reading value (format: Rack power user's manual)
91h	READ_FAN_SPEED_2	R Word	2	Fan speed 2 reading value (format: Rack power user's manual)
98h	PMBUS_REVISION	R Byte	1	The compliant revision of the PMBus (default: 11h for Rev. 1.1)
99h	MFR_ID	Block Read	12	Manufacturer's name
9Ah	MFR_MODEL	Block Read	12	Manufacturer's model name
9Bh	MFR_REVISION	Block Read	6	Firmware revision
9Ch	MFR_LOCATION	Block R/W	3	Manufacturer's factory location
9Dh	MFR_DATE	Block R/W	6	Manufacture date. (format: YYMMDD)
9Eh	MFR_SERIAL	Block R/W	12	Product serial number

Table 3-6

3.7.3 PMBus Data Range and Tolerance

All of the PMBus data are fully digitalized. The RKP-CMU1 uses the data read from Rack Power units to display their operating values and control these units. Take RCP-2000 as an example, Please refer to the definition of RCP-2000, as shown below, for Display / Control tolerance.

©Display parameters

PMBus command	Model	Range	Tolerance
READ_VIN	ALL	0 ~ 264V	±10V
READ_VOUT	12V	0 ~ 14V	±3%
	24V	0 ~ 28V	±3%
	48V	0 ~ 56V	±3%
READ_IOUT (Note)	12V	0 ~ 125A	±5A
	24V	0 ~ 100A	±4A
	48V	0 ~ 50A	±2A
READ_TEMPERATURE_1	ALL	0 ~ 100°C	±5°C
READ_FAN_SPEED_1	ALL	0 ~ 20000 RPM	±2000 RPM
READ_FAN_SPEED_2	ALL	0 ~ 20000 RPM	±2000 RPM

Table 3-7

Note: READ_IOUT readings will be displayed ZERO Amps when output current is less than values in the below table.

Model	Minimum readable current
12V	4A±1A
24V	3.2A±1A
48V	1.7A±1A

Table 3-8

◎Control parameters

PMBus command	Model	Adjustable range	Tolerance	Default
OPERATION	ALL	00h(OFF) / 80h(ON)	N/A	80h(ON)
VOUT_COMMAND	12V	12V	N/A	12V
	24V	24V	N/A	24V
	48V	48V	N/A	48V
VOUT_TRIM	12V	-1.5 ~ 2 V	±5%	0V
	24V	-3 ~ 4 V	±5%	0V
	48V	-6 ~ 8 V	±5%	0V
IOUT_OC_FAULT_LIMIT	12V	30 ~ 112A	±5A	112A
	24V	24 ~ 89.5A	±4A	89.5A
	48V	12.62 ~ 47 A	±2A	47A

Table 3-9

3.8 Notes on PMBus Monitoring

- 1.If Rack Power units is restarted, the parameters of Bus voltage and PSU current you have set will return to the initial/default values, whereas if Rack Power units is connected with a RKP-CMU1 unit, the restarted Rack Power will be loaded the previous set parameters by the RKP-CMU1 automatically.
- 2.If PMBus is offline such as RKP-CMU1 shutdown, the parameters of remote ON/OFF control, Bus voltage, and PSU current you have set will return to the initial/default values.
- 3.Using the RKP-CMU1 to reduce PSU current will just limit output current of RCP-2000 units and will not trigger their over-current alarm. Take RCP-2000-48 as an example, the over-current protection threshold is 47A when operating at 230Vac. If you set PSU current to 40A, then the maximum output current will be 40A. It is less than 47A, so its over-current alarm will not be triggered.
- 4.If PSU current you set is higher than the auto de-rating value of the rack PSU when operating at a low AC input voltage, it will trigger the de-rated over-current protection. Take RCP-2000-48 as an example, the over-current protection threshold decreases by 25%, from 47A to 35.25A, when operating at 100Vac. If you set PSU current to 40A, it will trigger over-current alarm due to the lower over-current protection threshold (35.25A).

3.9 Parallel Operation

- ◎To configure a Rack Power power management system, the JK1 ports on the rear of each rack units must be connected together owing to the face that all control and parameter signals of the RKP-CMU1 are integrated into JK1.
- ◎Only a single RKP-CMU1 unit is allowed to be used in a Rack Power management system.
- ◎Do not use the "RKP-1U ON/OFF" function in the Rack Power management system, because this will interfere in RKP-CMU1/ RKP-1U-CMU1's proper operation.
- ◎Because of component tolerance, there is a possibility that some of units connected in parallel will reach an overcurrent limit then overloading the other units when operating at full load condition. If overload conditions happen in parallel usage, it is suggested that derate the total output current by 10%. For example: RCP-2000-24 × 9 connected in parallel (in 3 racks), the total output current should be changed to 80A × 9 unit × 0.9=648A.
- ◎Connect rack units in parallel before linking to the load. Do not connect rack units to the load separately. Refer to Figure 3-2 and Figure 3-3.
- ◎Use twisted wires for the wiring of +S and S. The twisted wires should not touch the load wires to avoid interference. Refer to Figure 3-2 and Figure 3-3.
- ◎A too long cable length might induce a higher amount of noise that affects rack units' proper operation in parallel. To reduce the noise, installing termination resistors, an accessory, to the unused JK1 ports is recommended.

3.9.1 Parallel operation of a single unit of RKP-1U-CMU1

- ◎RKP-1U-CMU1 is equipped with the circuit for connecting RCP-2000 units in parallel. Just insert RCP-2000 units into the rack, then units to be connected in parallel is done.
- ◎Internal parallel operation of a rack unit is only suitable for the identical RCP-2000 units, namely units with the same output voltage and current rating.
- ◎Under parallel operation, please refer to the user's manual of RCP-2000/RKP-1U for notice of operation and connections of the rest of the functions.

3.9.2 Parallel operation of RKP-1U-CMU1 and RKP-1U

- ◎Parallel operation of rack units is only suitable for the identical RCP-2000 units, namely units with the same output voltage and current rating. Up to three rack units including a RKP-1U-CMU1 and two RKP-1Us (eight RCP-2000 units) can be connected in parallel, as Figure 3-2 shows.
- ◎RJ45 cables (CAT.5e, 8P8C) must be used to connect the JK1 ports of each rack units. The recommended maximum length is 1m. But if there is a need for extending the cables, the maximum length should not exceed 2m.

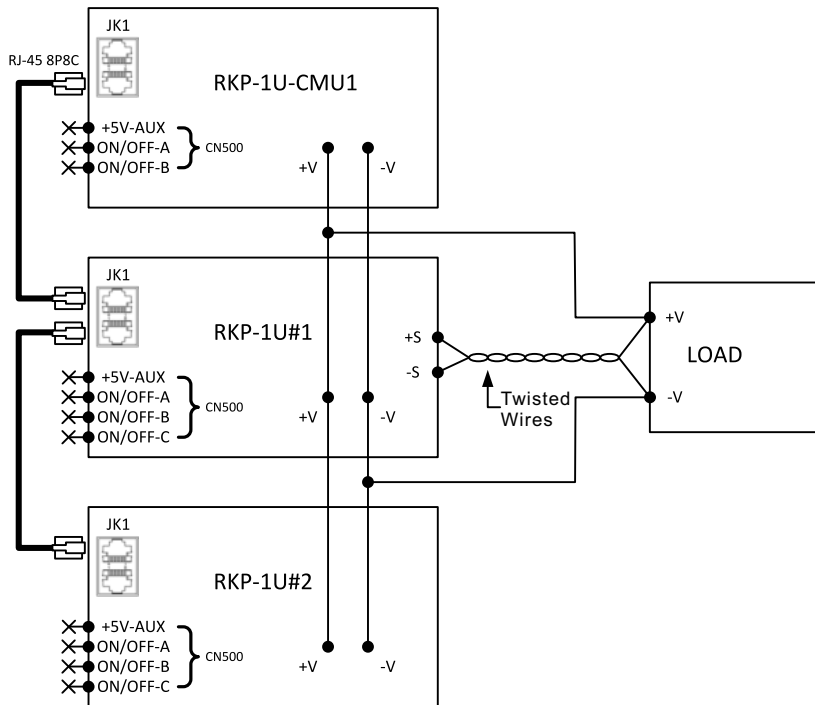

Figure 3-2 Configuration of a RKP-1U-CMU1 and two RKP-1Us

3.9.3 Using RKP-CMU1 to monitor RKP-1Us

- ◎ RKP-CMU1 is capable of monitoring and controlling up to three RKP-1Us (nine RCP-2000 units). Please refer to the user's manual of RCP-2000/RKP-1U and Figure 3-3 for notes on parallel operation of RKP-1Us.
- ◎ RJ45 cables (CAT.5e, 8P8C) must be used to connect the JK1 ports of each rack units. The recommended maximum length is 1m. But if there is a need for extending the cables, the maximum length should not exceed 2m.

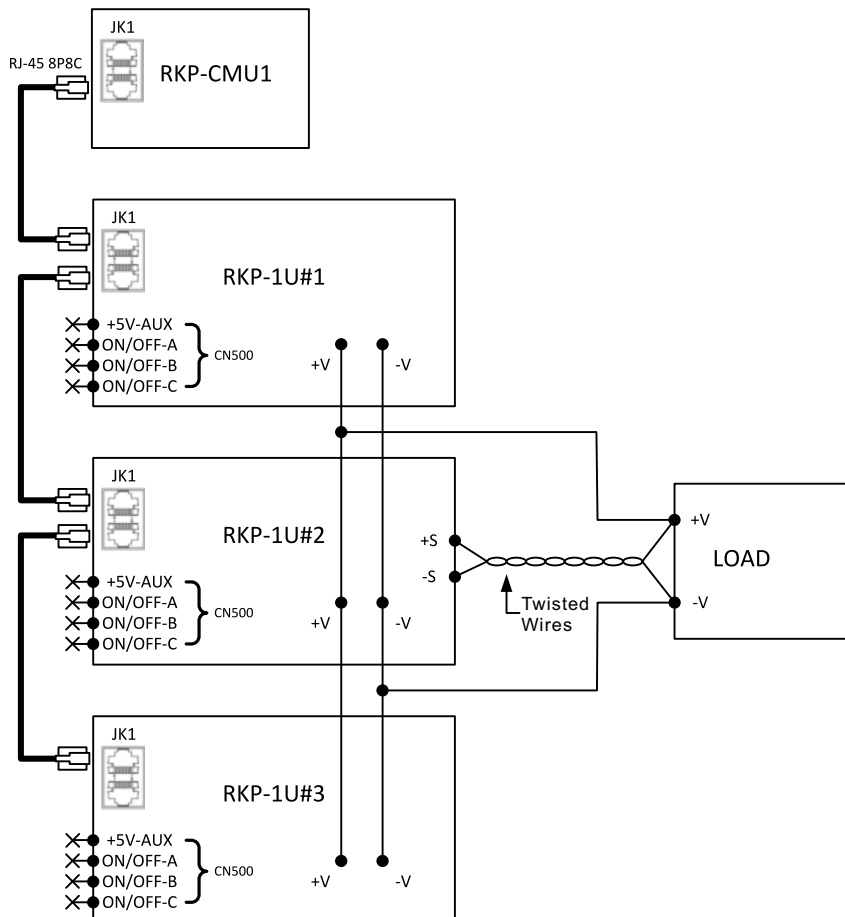

Figure 3-3 Configuration of a RKP-CMU1 and three RKP-1Us

3.10 Series Operation

The RKP-CMU1 is specifically designed to monitor, manage, and control RCP-2000 units in parallel. As a result, it cannot be used for RCP-2000 units connected in series. If you do need this application, contact our distributors or MEANWELL for details.

4.RKP-CMU1 LCD User Interface

4.1 Description of RKP-CMU1 Front Panel

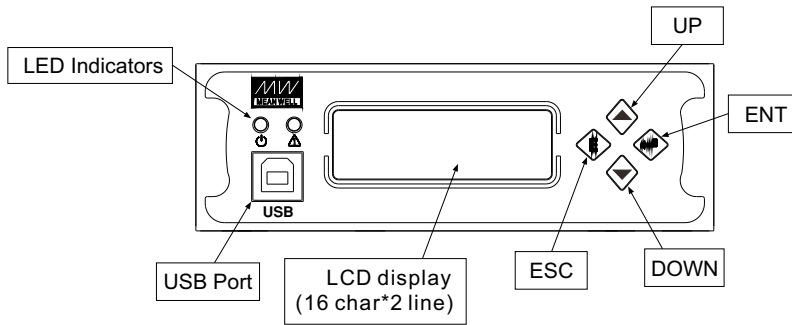
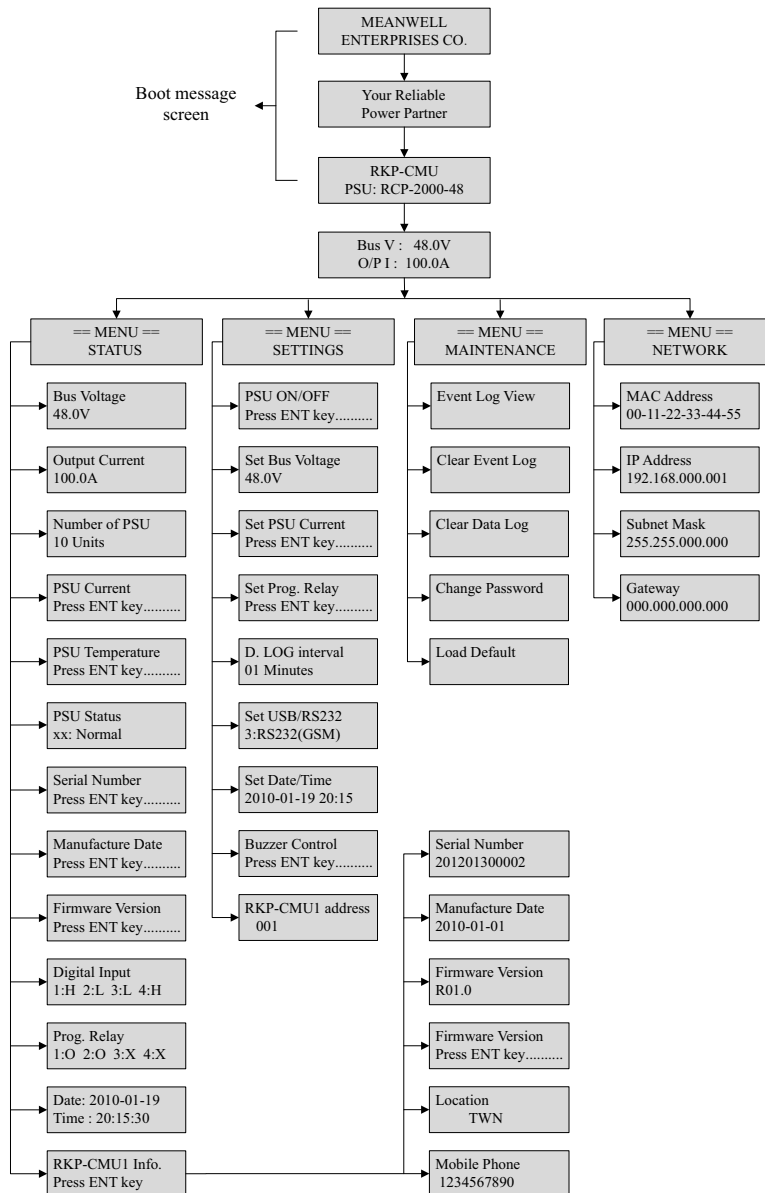

Figure 4-1 Diagram of RKP-CMU1 front panel

4.2 LCD Display

4.2.1 Menu Structure



4.2.2 Main Page

The "Main Page" displays the current Bus voltage and total output current.

B	u	s		V	:		4	8	.	0	V	
O	/	P		I	:		1	0	0	.	0	A

In the "Main Page", once you press the "ESC" button for over 1.5 sec, you will enter the "Sub Screen", where you can adjust the brightness of LCD backlight and the LCD contrast ratio. There are 8 levels available for both the LCD backlight and the LCD contrast to be selected. As demonstrated on the screen below, "x" indicates your current level.

L	C	D		B	a	c	k	l	i	g	h	t		
x	-	[.	.	.	.	*	.	.	.]	+		

L	C	D		C	o	n	t	r	a	s	t			
x	-	[.	.	.	.	*	.	.	.]	+		

In the "Main Page", once you press the "ENT" button, you will enter the "Menu Page". There are "Status Menu", "Settings Menu", "Maintenance Menu", and "Network Menu" that can be selected through the "UP"/"DOWN" buttons in this screen, as shown below.

			=	=		M	E	N	U		=	=		
						S	T	A	T	U	S			

			=	=		M	E	N	U		=	=		
						S	E	T	T	I	N	G	S	

			=	=		M	E	N	U		=	=				
						M	A	I	N	T	E	N	A	N	C	E

			=	=		M	E	N	U		=	=		
						N	E	T	W	O	R	K		

4.3 Status Menu

Under the "Status Menu", status information, including Bus voltage, total output current, numbers of PSUs in parallel, PSU current, PSU temperature, PSU status, PSU serial number, PSU manufacture date, PSU firmware version, condition of digital input signal, condition of programmable relay, date, and RKP-CMU1 information, can be selected through the "UP"/"DOWN" buttons.

4.3.1 Bus Voltage

B	u	s		V	o	l	t	a	g	e				
4	8	.	0	V										

4.3.2 Total Output Current

O	u	t	p	u	t		C	u	r	r	e	n	t		
1	0	0	.	0	A										

4.3.3 Numbers of PSUs in Parallel

P	S	U		C	o	n	n	e	c	t	i	o	n		
1	0			U	n	i	t	s							

4.3.4 PSU Current

In the "PSU Current" section, each of the PSU's output currents can be displayed by pressing the "ENT" button.

P	S	U		C	u	r	r	e	n	t					
P	r	e	s	s		E	N	T		k	e	y	.	.	.

Once you entered this page, you can choose one of the PSU's output currents to be displayed on the screen through the "UP"/"DOWN" buttons. "xx" indicates PSU's number.

P	S	U		C	u	r	r	e	n	t					
X	X	:		2	0	.	0		A						

When "N/A" is displayed on the screen, it means that the number of unit is offline.

P	S	U		C	u	r	r	e	n	t					
X	X	:		N	/	A									

4.3.5 PSU Temperature

In the "PSU Temperature" section, each of the PSU's temperatures can be displayed by pressing the "ENT" button.

P	S	U		T	e	m	p	e	r	a	t	u	r	e	
P	r	e	s	s		E	N	T		k	e	y	.	.	.

Once you entered this page, you can choose one of the PSU's temperatures to be displayed on the screen through the "UP"/"DOWN" buttons. "xx" indicates PSU's number.

P	S	U		T	e	m	p	e	r	a	t	u	r	e	
x	x	:		+	5	0		d	e	g	C				

When "N/A" is displayed on the screen, it means that the number of unit is offline.

P	S	U		T	e	m	p	e	r	a	t	u	r	e	
x	x	:		N	/	A									

4.3.6 PSU Status

In the "PSU Status" section, each of the PSU's statuses can be displayed by pressing the "ENT" button.

P	S	U		S	t	a	t	u	s						
P	r	e	s	s		E	N	T		k	e	y	.	.	.

Once you entered this page, you can choose one of the PSU's statuses to be displayed on the screen through the "UP"/"DOWN" buttons. "xx" indicates PSU's number. If an abnormal situation occurs, the screen will display which PSU unit is and its situation, no matter which unit you have chosen. Abnormal situations that can be displayed include OVP, OLP, OTP, Short Ckt, High temp., AC fail, and fan lock.

P	S	U		S	t	a	t	u	s					
x	x	:		N	o	r	m	a	l					

4.3.7 PSU Serial Number

In the "PSU Serial No." section, each of the PSU's serial numbers can be displayed by pressing the "ENT" button.

P	S	U		S	e	r	i	a	l		N	o	.		
P	r	e	s	s		E	N	T		k	e	y	.	.	.

Once you entered this page, you can choose one of the PSU's serial numbers to be displayed on the screen through the "UP"/"DOWN" buttons. "xx" indicates PSU's number.

P	S	U		S	e	r	i	a	l		N	o	.		
x	x	:		2	0	1	2	0	1	3	0	0	0	0	1

4.3.8 PSU Manufacture Date

In the "PSU Mfg. Date" section, each of the PSU's manufacture dates can be displayed by pressing the "ENT" button.

P	S	U		M	f	g	.		D	a	t	e			
P	r	e	s	s		E	N	T		k	e	y	.	.	.

Once you entered this page, you can choose one of the PSU's manufacture dates to be displayed on the screen through the "UP"/"DOWN" buttons. "xx" indicates PSU's number.

P	S	U		M	f	g	.		D	a	t	e			
X	X	:		2	0	1	0	-	0	1	-	0	1		

4.3.9 PSU Firmware Version

In the "Firmware Ver" section, each of the PSU's firmware versions can be displayed by pressing the "ENT" button.

P	S	U		F	i	r	m	w	a	r	e		V	e	r
P	r	e	s	s		E	N	T		k	e	y	.	.	.

Once you enter this page, you can choose one of the PSU's firmware versions to be displayed on the screen through the "UP"/"DOWN" buttons. "xx" indicates PSU's number.

P	S	U		F	i	r	m	w	a	r	e		V	e	r
x	x	:		R	0	1	.	0							

4.3.10 Condition of Digital Input signal

In the "Digital Input" section, it displays the condition of each digital input signals. "H" indicates a high voltage level, while "L" indicates a low voltage level.

D	i	g	i	t	a	l		I	n	p	u	t			
1	:	H		2	:	L		3	:	L		4	:	H	

4.3.11 Condition of Programmable Relay

In the "Prog. Relay" section, it displays the condition of each programmable relays. "x" indicates that the relay is inactive and its COM contacts the "NC". "o" indicates that the relay is activated, and its COM is contacting the "NO".

P	r	o	g	.		R	e	l	a	y				
1	:	o		2	:	o		3	:	x		4	:	x

4.3.12 RKP-CMU1 Information

In the "RKP-CMU1 Info." section, there are the serial number, the manufacture date, the firmware version, country of production, and the GSM phone number of the RKP-CMU1 that can be displayed by pressing the "ENT" button.

R	K	P	-	C	M	U		I	n	f	o	.		
P	r	e	s	s		E	M	T		k	e	y	.	.

Serial number of RKP-CMU1

S	e	r	i	a	l		N	u	m	b	e	r		
2	0	1	2	0	1	3	0	0	0	0	2			

Manufacture date of RKP-CMU1

M	a	n	u	f	a	c	t	u	r	e		D	a	t	e
2	0	1	0	-	0	1	-	0	1						

Firmware version of RKP-CMU1

F	i	r	m	w	a	r	e		V	e	r	s	i	o	n
R	0	0	.	0											

Country of production of RKP-CMU1

	L	o	c	a	t	i	o	n							
		T	W	N											

GSM phone number of RKP-CMU1

M	o	b	i	l	e		P	h	o	n	e				
	1	2	3	4	5	6	7	8	9	0					

If there is no phone number been stored yet, it will display "UNSPECIFIED".

If you would like to set a GSM phone number, refer to "Section 6.3.7" for details.

	U	N	S	P	E	C	I	F	I	E	D				
--	---	---	---	---	---	---	---	---	---	---	---	--	--	--	--

4.4 Settings Menu

Under the "Settings Menu", there are PSU ON/OFF setting, Bus voltage setting, PSU current setting, PSU alarm setting, programmable relay setting, Data Log Interval, communication port setting (USB/RS232), date and time setting, buzzer ON/OFF setting, and RKP-CMU1 address setting that can be selected through the "UP"/"DOWN" buttons.

4.4.1 PSU ON/OFF Setting

In this page, you can enter PSU ON/OFF setting by pressing the "ENT" button when this option is on the screen.

P	S	U		O	N	/	O	F	F					
P	r	e	s	s		E	N	T		k	e	y	.	.

Once you entered this screen, you can choose which PSU you would like to turn on or off through the "UP"/"DOWN" buttons. It is also possible to control the whole units by changing "xxx" to "ALL". "xxx" indicates PSU's number.

P	S	U		O	N	/	O	F	F					
x	x	x	:		O	F	F							

If "OFF (Alarm)", or "N/A" is displayed, that means the PSU is in an abnormal situation or offline. In this case, the PSU cannot be controlled.

x	x	x	:		O	F	F	(A	l	a	r	m)
---	---	---	---	--	---	---	---	---	---	---	---	---	---	---

x	x	x	:		N	/	A							
---	---	---	---	--	---	---	---	--	--	--	--	--	--	--

Once you have chosen a PSU, pressing the "ENT" button will change its setting (on or off).

P	S	U		X	X			O	F	F	>	O	N	?
E	N	T	:	Y	E	S		E	S	C	:	N	O	

Once you chose all units, the displayed screen will show as below. "yy" indicates numbers of units set to be ON, "zz" indicates numbers of units set to be OFF, "FULL OFF" indicates all the units set to be OFF, and "FULL ON" indicates all the units set to be ON. For changing the setting (on or off), press the "ENT" button.

P	S	U		O	N	/	O	F	F						
A	I	I	:	y	y		O	N	,	z	z		O	F	F

A	I	I	:		F	U	L	L		O	F	F		
---	---	---	---	--	---	---	---	---	--	---	---	---	--	--

A	I	I	:		F	U	L	L		O	N			
---	---	---	---	--	---	---	---	---	--	---	---	--	--	--

4.4.2 Bus Voltage Setting

Once you entered this page, you can trim the Bus voltage through the "UP"/"DOWN" buttons. Refer to the Table of PSU adjustable voltage range.

Increment of voltage adjustment is defined on the basis of PMBus format N in user's manual of specific rack power. Take RCP-2000 as an example, as $N=-9$, $2^N = 1.9 \times 10^{-3}$. Adjust increment to 1.9×10^{-3} , LCD panel only displays one digit after decimal separator.

S	e	t		B	u	s		V	o	l	t	a	g	e
4	8	.	0		V									

PSU adjustable voltage range, take RCP-2000 for example, please refer to its user's manual.

Model	Bus Voltage Range	Default
12V	10.5 ~ 14V	12V
24V	21 ~ 28V	24V
48V	42 ~ 56V	48V

4.4.3 PSU Current Setting

In the "Set PSU Current" section, you can enter PSU current setting by pressing the "ENT" button when this option is on the screen.

Increment of current adjustment is defined on the basis of PMBus format N in user's manual of specific rack power. Take RCP-2000 as an example, as $N=-3$, $2^N = 0.125$. Adjust increment to 0.125A. LCD panel only displays two digits after decimal separator.

S	e	t		P	S	U		C	u	r	r	e	n	t	
P	r	e	s	s		E	N	T		k	e	y	.	.	.

Once you entered this page, you can trim the output current through the "UP"/"DOWN" buttons. Refer to the Table of PSU adjustable current range.

S	e	t		P	S	U		C	u	r	r	e	n	t	
	2	0	.	0	A										

PSU adjustable current range, Take RCP-2000 for example, please refer to its user's manual.

Model	PSU Current Range	Default
12V	30 ~ 112A	112A
24V	24 ~ 89.6A	89.5A
48V	12.62 ~ 47A	47A

Note : If the set PSU current exceeds 100A, the maximum rated current, OTP might be triggered after operating a period of time.

4.4.4 Programmable Relay Setting

When the "Set Prog. Relay" option is on the screen, you can enter programmable relay settings by pressing the "ENT" button. (Default value: Alarm (activate) Any Alarm)

S	e	t		P	r	o	g	.		R	e	l	a	y	

Once you entered this page, you can choose which relay you would like to modify through the "UP"/"DOWN" buttons. There are four relays available to be selected.

0	1	:		A	l	a	r	m							
				A	n	y	A	l	a	r	m				

Each relay can be set for the functions below :

1. Alarm activating: Any Alarm, OVP, OLP, OTP, Short circuit, High Temp., AC Fail, Fan lock, or PMBus Error.
2. PSU ON activating: Immediately, or Delay (1~600 sec).
3. PSU OFF activating: Immediately, or Delay (1~600 sec).
4. Digital I/P activating: Control by DI1, control by DI2, control by DI3, or control by DI4.

4.4.5 Data Log Interval Setting

Once you entered this page, you can set Data Log's time interval, from 1 to 60 minutes, through the "UP"/"DOWN" buttons. (Default value: 5 minutes)

D	.		L	o	g		i	n	t	e	r	v	a	l	
0	1		M	i	n	u	t	e	s						

4.4.6 Communication Port Setting (USB/RS232)

In the "Set USB/RS232" section, there are USB, RS232, and RS232 for GSM interface that can be selected. (Default: USB)

S	e	t		U	S	B	/	R	S	2	3	2			
1	:		U	S	B										

S	e	t		U	S	B	/	R	S	2	3	2			
2	:		R	S	2	3	2								

S	e	t		U	S	B	/	R	S	2	3	2			
3	:		R	S	2	3	2		f	o	r		G	S	M

4.4.7 Date and Time Setting

Under "Set Date/Time", "yy" indicates year, "mm/dd" indicates month/day, and "HH/MM" indicates hour/minute. Press the "ENT" button to select year, month, day, hour, or minute. Then, use the "UP"/"DOWN" buttons to choose a number.

S	e	t		D	a	t	e	/	T	i	m	e			
2	0	y	y	-	m	m	-	d	d		H	H	:	M	M

4.4.8 Buzzer ON/OFF Setting

Under "Buzzer Control", you can turn buzzer on or off by pressing the "ENT" button. (Default: ON Buzzer)

B	u	z	z	e	r		C	o	n	t	r	o	l		
P	r	e	s	s		E	N	T		k	e	y	.	.	.

4.4.9 RKP-CMU1 Address Setting

In the "RKP-CMU1 address" section, you can set RKP-CMU1's address by pressing the "ENT" button. (Default: 1)

R	K	P	-	C	M	U	1	a	d	d	r	e	s	s	:
		0	0	1											

4.5 Maintenance Menu

A password is required to enter this menu. Once you entered this menu, there are "view Event Log", "clear Event Log", "clear Data Log", "change password", and "load default settings" that can be selected.

Four digits are needed for a password, entering a password can use the "UP"/"DOWN" buttons to choose a number, from 0 to 9, then press the "ENT" button to the next digit. (Default password: 0000)

	P	A	S	S	W	O	R	D		K	E	Y	.	.	.
						0	0	0	0						

4.5.1 View Event Log

The Event log stores abnormal system conditions when alarms occur. It is capable of saving up to 600 records and the contents include time, type of alarm, which PSU.

E	v	e	n	t		L	o	g		V	i	e	w		

Once you entered this page, you can choose a LOG number or a date through the "UP"/"DOWN" buttons to access the information you need.

N	o	:		0	0	1									
2	0	1	1	-	1	1	-	2	1						

Once you chose a LOG number/date, it will display when it occurs and which types of alarm it is.

1	3	:	2	4	:	1	4								
C	M	U	:		P	M	B	u	s		e	r	r	o	r

4.5.2 Clear Event Log

The "Clear Event Log" function is used to clear all the data that Event log has stored.

C	l	e	a	r		E	v	e	n	t		L	o	g	

4.5.3 Clear Data Log

The "Clear Data Log" function is used to clear all the data that Data log has stored.

The content of Data log include AC voltage, relay condition, condition of digital input signal, output voltage, total output current, each PSU's currents, and time. The content of Data log is possible to be accessed by the built-in web page or monitoring software.

C	l	e	a	r		D	a	t	a			L	o	g	

4.5.4 Change Password

The "Change Password" function is used to change a password for entering the "Maintenance Menu".

C	h	a	n	g	e		P	a	s	s	w	o	r	d	

4.5.5 Load Default Setting

The "Load Default" is used to reset the parameters of the "Settings Menu" to its default value.

L	o	a	d		D	e	f	a	u	l	t				

4.6 Network Menu

Once you entered the "Network Menu", there are MAC address, IP address, subnet mask, and gateway (support IP v4) that can be selected.

4.6.1 MAC Address

Each RKP-CMU1 unit has a different MAC address, and the address is assigned by the internal hardware.

M	A	C				0	0	-	2	2	-	1	5	
A	d	d	r	.		-	C	6	-	3	B	-	8	B

4.6.2 IP Address

IP address can be changed by the built-in web page, but doing so requires the RKP-CMU1 and the PC you use in the same domain. (Default IP: 169.254.1.1)

I	P		A	d	d	r	e	s	s					
1	6	9	.	2	5	4	.	0	0	1	.	0	0	1

4.6.3 Subnet Mask

Subnet mask can be changed by the built-in web page, but doing so requires the RKP-CMU1 and the PC you use in the same domain. (Default IP: 255.255.0.0)

S	u	b	n	e	t		M	a	s	k				
2	5	5	.	2	5	5	.	0	0	0	.	0	0	0

4.6.4 Gateway

Gateway can be changed by the built-in web page, but doing so requires the RKP-CMU1 and the PC you use in the same domain. (Default IP: 169.254.1.1)

G	a	t	e	w	a	y								
1	6	9	.	2	5	4	.	0	0	1	.	0	0	1

5.RKP-CMU1 Web Page Monitoring Functions

◎System requirements

- 1.Windows XP, Windows Vista, or Windows 7 operating system
- 2.AMD or Intel Pentium 133MHz or better based computer
- 3.10/100 BASE-T Ethernet port
- 4.Microsoft IE6(and above)

◎Connection diagram

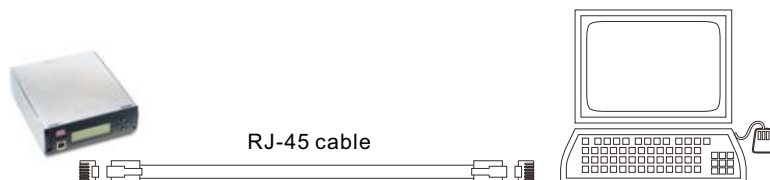

◎Before accessing the built-in web page, please make sure that the RKP-CMU1 and the PC you use are set in the same domain. If this is the first time you access the built-in web page, you will need to change the IP address of your PC. Once you connected the built-in web page, change of the RKP-CMU1's address settings (like to another domain) can be done. Refer to section 5.5 TCP/IP Config. Page for details.

※Default address of RKP-CMU1

Address	Default
IP address	169.254.1.1
Subnet mask	255.255.0.0
Default gateway	169.254.1.1

5.1 IP Setting of PC

Please follow the following instruction to set the IP address of your PC.

- (1)Only connect your PC to the RKP-CMU1, and verify that there are no other devices connecting to your PC like a modem.
- (2)Click the "Network and Internet Connections" option. Then click the "Local Area Connection". Select "Internet Protocol (TCP/IP)", and then click the "Properties" button. If there are "Internet Protocol Version 4 (TCP/IPv4)" and "Internet Protocol Version 6 (TCP/IPv6)" shown on the table, choose "Internet Protocol Version 4 (TCP/IPv4)".

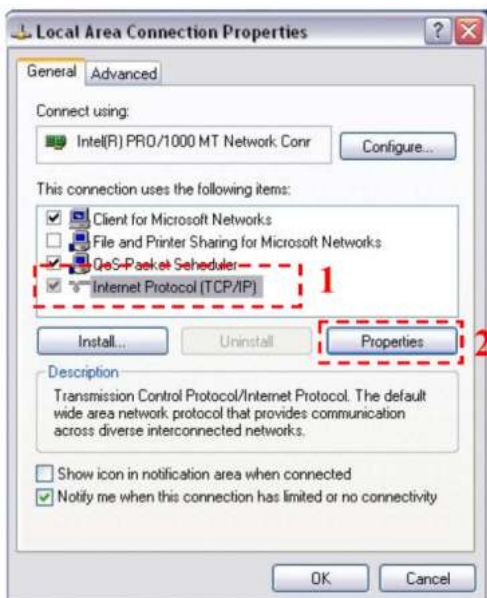

- (3)Click the "Use the following IP address", and then type addresses in "IP address", "Subnet mask", and "Default gateway" boxes. After that click the "OK" button. The IP address you set should be in the same domain as RKP-CMU1 but not the identical IP. There is an example below for your reference.

Address	Default (for ex.)
IP address	169.254.1.2
Subnet mask	255.255.0.0
Default gateway	169.254.1.1

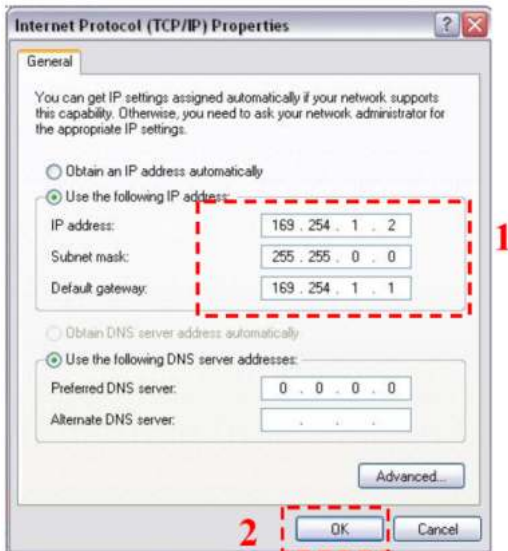

(4) Check if it is working correctly by clicking the "Support". If the addresses presented as you typed, it is successfully done. Then you can access the built-in web page.



If the table shows as below, it means that your RJ-45 cable is not properly connected or the IP address you have set is incorrect.



5.2 Description of RKP-CUM1 Built-in Web Page

5.2.1 How to open the website

Connect your PC to the RKP-CMU1, then open a blank page and type the IP address of the RKP-CMU1 in the address bar. If you are not sure the IP address of RKP-CMU1, refer to the LCD user interface. The route is "Main Page" → "Menu Page" → "IP Address". (Default IP: 169.254.1.1)



5.2.2 CMU Status Page

The home page of the built-in web page is the "CMU Status". This page displays important information including Bus voltage, total output current, the conditions of digital input signals, the conditions of programmable relays, the information of RKP-CMU1, PSU status, and numbers of online units.

CMU Status

PSU Status

Configuration

EventLOG

DataLOG

TCP/IP Config.

Bus Voltage / Output Current Display

Bus Voltage : 12.1V

Output Current : 17.3A

Total connection: 2PSU

00: ●	01: ●
02: N/A	03: N/A
04: N/A	05: N/A
06: N/A	07: N/A
08: N/A	09: N/A
10: N/A	11: N/A
12: N/A	13: N/A
14: N/A	15: N/A
16: N/A	17: N/A
18: N/A	19: N/A
20: N/A	21: N/A
22: N/A	23: N/A
24: N/A	25: N/A
26: N/A	27: N/A
28: N/A	29: N/A
30: N/A	31: N/A

Red: PSU OFF
Green: PSU ON
N/A: No connect

Relay Status

Relay1: ON

Relay2: OFF

Relay3: OFF

Relay4: OFF

Digital input Status

Input1: HIGH

Input2: LOW

Input3: HIGH

Input4: LOW

RKP-CMU Information

Location : TWN

Serial: 111117000002

Date: 2011/11/17/

Revision: R01.0

5.2.3 PSU Status Page

The "PSU Status" page displays the operating information of each PSU, including output current, internal temperature, serial number, firmware version, alarm, and status.



PSU	Current	Temperature	SerialNo.	FirmwareVer	Alarm	Status
0	18.0	27	110607000004	R01.3	Normal	ON
1	0	26	110607000004	R01.4	Normal	OFF
2	0	0	N/A	N/A	N/A	N/A
3	0	0	N/A	N/A	N/A	N/A
4	0	0	N/A	N/A	N/A	N/A
5	0	0	N/A	N/A	N/A	N/A
6	0	0	N/A	N/A	N/A	N/A
7	0	0	N/A	N/A	N/A	N/A
8	0	0	N/A	N/A	N/A	N/A
9	0	0	N/A	N/A	N/A	N/A
10	0	0	N/A	N/A	N/A	N/A
11	0	0	N/A	N/A	N/A	N/A
12	0	0	N/A	N/A	N/A	N/A
13	0	0	N/A	N/A	N/A	N/A
14	0	0	N/A	N/A	N/A	N/A
15	0	0	N/A	N/A	N/A	N/A
16	0	0	N/A	N/A	N/A	N/A
17	0	0	N/A	N/A	N/A	N/A
18	0	0	N/A	N/A	N/A	N/A
19	0	0	N/A	N/A	N/A	N/A
20	0	0	N/A	N/A	N/A	N/A
21	0	0	N/A	N/A	N/A	N/A
22	0	0	N/A	N/A	N/A	N/A
23	0	0	N/A	N/A	N/A	N/A
24	0	0	N/A	N/A	N/A	N/A
25	0	0	N/A	N/A	N/A	N/A
26	0	0	N/A	N/A	N/A	N/A
27	0	0	N/A	N/A	N/A	N/A
28	0	0	N/A	N/A	N/A	N/A
29	0	0	N/A	N/A	N/A	N/A
30	0	0	N/A	N/A	N/A	N/A
31	0	0	N/A	N/A	N/A	N/A

Copyright © R 2011 MEAN WELL Enterprises Co., Ltd. All rights reserved.

5.2.4 Configuration Page

Once you clicked the "Configuration" page, you will be asked to enter a user name and a password. Type "meanwell" (small letters) in both the "User name" and "Password" boxes to enter this page, as shown below. This user name and password cannot be changed.



Once you insert the correct user name and password, you will enter the settings page. On this page, there are Bus voltage, PSU over-current, clear Event Log/Data Log, Data Log time interval setting, programmable relay setting, and PSU ON/OFF that can be set and altered.

5.2.4.1 Bus Voltage / PSU Current

If the Bus voltage/PSU current you set is not within the adjustable range, it will become invalid. Make sure the parameters that you type in are not over or less than the range as below.

Adjustable range of Bus voltage/ PSU current, take RCP-2000 for example, please refer to its user's manual.

Model	Bus voltage range	PSU current range
12V	10.5 ~ 14V	30 ~ 112A
24V	21 ~ 28V	24 ~ 89.5A
48V	42 ~ 56V	12.62 ~ 47A

Note : If the set PSU current exceeds 100A, the maximum rated current, OTP might be triggered after operating a period of time.

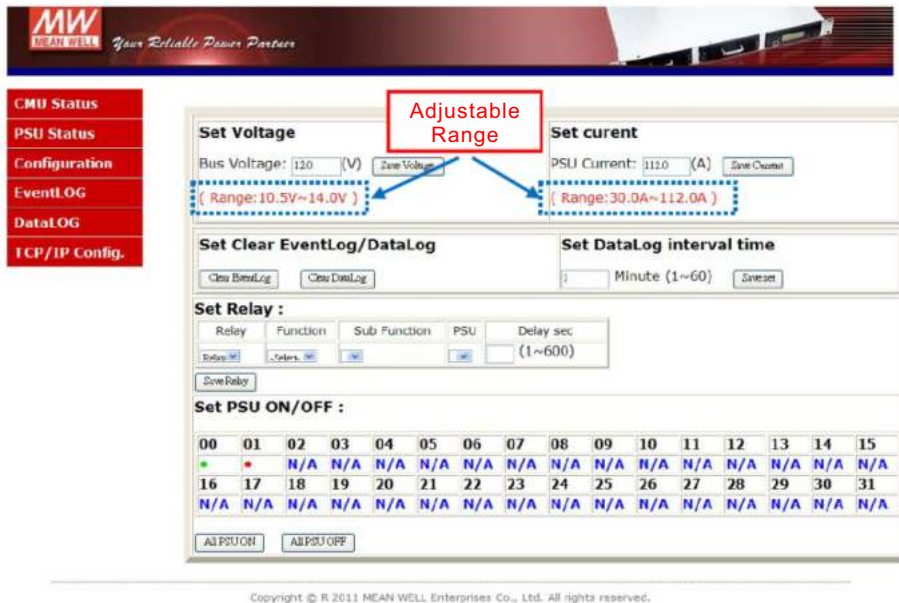

5.2.4.2 Setting of Clear EventLog/DataLog and DataLog Time Interval

The "Set Clear EventLog/DataLog" box is used to clear the data that Event log/Data log has stored, while the "Set DataLog time interval" box can set the time interval from 1 to 60 minutes.



5.2.4.3 Setting of Programmable Relay

Each relay can be set for the functions below :

- 1.Alarm activating: Any Alarm, OVP, OLP, OTP, Short circuit, High Temp., AC Fail, Fan lock, or PMBus Error.
- 2.PSU ON activating: Immediately, or Delay (1~600 sec).
- 3.PSU OFF activating: Immediately, or Delay (1~600 sec).
- 4.Digital I/P activating: Control by DI1, control by DI2, control by DI3, or control by DI4.

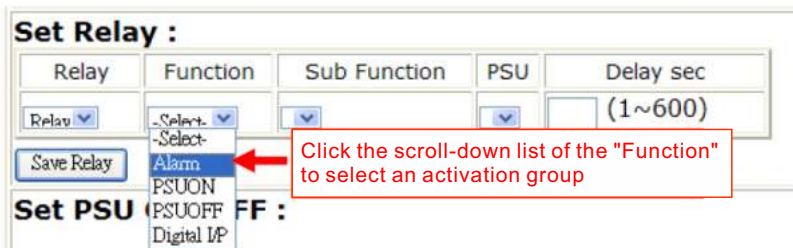

Set Relay :

Relay	Function	Sub Function	PSU	Delay sec
Relay	Alarm	-Select		(1~600)
<div style="border: 1px solid red; padding: 2px;"> Then, click the scroll-down list of the "Sub Function" to choose an activation type </div>				

Set PSU ON/OFF :

00	01	02	0	05
16	17	18	1	21

Set Relay :

Relay	Function	Sub Function	PSU	Delay sec
Relay	PSU ON	Delay	PSU01	12 (1~600)

Type a delay time value to decide how much time it need to be delayed

5.2.4.3 PSU ON/OFF setting

If you would like to turn a PSU on or off, double click its status bar under its number. "Green" indicates "PSU ON", "Red" indicates "PUS OFF", and "N/A" indicates "unconnected". If you double click a status bar displayed green, it will shift to red, whereas if the status bar you double clicked is red, it will switch to green. If a status bar displays "N/A", it cannot be controlled due to non-connection to the RKP-CMU1. Turning the whole PSU units on or off is also possible by clicking the "ALL PSU ON"/ "ALL PSU OFF" buttons. The updated status will not immediately reflect in its status bar, it may delay 1~3 seconds.

Set PSU ON/OFF :

00	01	02	03	04	05	06	07	08	09	10	11	12	13	14	15
•	•	N/A	N/A	N/A	N/A	N/A	N/A	N/A	N/A	N/A	N/A	N/A	N/A	N/A	N/A
16	17	18	19	20	21	22	23	24	25	26	27	28	29	30	31
N/A	N/A	N/A	N/A	N/A	N/A	N/A	N/A	N/A	N/A	N/A	N/A	N/A	N/A	N/A	N/A

Status bar

All PSU ON All PSU OFF

5.3 Event Log Page

The Event Log stores abnormal system situations when alarms occur. It is capable of saving 600 records, but if the stored data is over its capacity, it will overwrite the previous data, from the first record. The contents that Event Log stores include time, type of alarm, and which PSU. The "EventLog" page displays 10 records in one page, and pages can be selected by the "scroll-down list".



Number	PSU/CMU	Alarm	Time
81	PSU00	AC Fault,	2012-11-15 10:04:01
82	CMU	PMBus Error,	2012-11-15 10:04:06
83	CMU	Alarm Remove	2012-11-15 10:04:11
84	PSU00	Alarm Remove	2012-11-15 10:04:16
85	PSU00	AC Fault,	2012-11-15 10:04:45
86	CMU	PMBus Error,	2012-11-15 10:04:50
87	PSU00	Alarm Remove	2012-11-15 10:04:55
88	CMU	Alarm Remove	2012-11-15 10:05:00
89	PSU00	AC Fault,	2012-11-15 10:05:07
90	CMU	PMBus Error,	2012-11-15 10:05:13

-select- Page

5.4 Data Log Page

The Data Log will save operating data at regular intervals set by "Data log interval". The Data Log is capable of saving 1000 records, but if the stored data is over its capacity, it will overwrite the previous data, from the first record. The contents that Data Log stores include AC voltage, relay condition, condition of digital input signal, output voltage, total output current, each PSU's currents, and time. The "DataLog" page displays 10 groups of data in one page, and pages can be selected by the "scroll-down list".

N	Relay	D.Input	BusV	Total	Vac	PSU 1 (A)	Time
1	R1:ON	D1:High	0V	0A	Max: 0V Min: 0V	00:(0) 08:(0) 16:(0) 24:(0)	2011-11-22 11:07
	R2:ON	D2:High				01:(0) 09:(0) 17:(0) 25:(0)	
	R3:ON	D3:High				02:(0) 10:(0) 18:(0) 26:(0)	
	R4:ON	D4:High				03:(0) 11:(0) 19:(0) 27:(0)	
2	R1:ON	D1:High	0V	0A	Max: 0V Min: 0V	04:(0) 12:(0) 20:(0) 28:(0)	2011-11-22 11:08
	R2:ON	D2:High				05:(0) 13:(0) 21:(0) 29:(0)	
	R3:ON	D3:High				06:(0) 14:(0) 22:(0) 30:(0)	
	R4:ON	D4:High				07:(0) 15:(0) 23:(0) 31:(0)	
3	R1:ON	D1:High	0V	0A	Max: 0V Min: 0V	00:(0) 08:(0) 16:(0) 24:(0)	2011-11-22 11:09
	R2:ON	D2:High				01:(0) 09:(0) 17:(0) 25:(0)	
	R3:ON	D3:High				02:(0) 10:(0) 18:(0) 26:(0)	
	R4:ON	D4:High				03:(0) 11:(0) 19:(0) 27:(0)	
4	R1:ON	D1:High	0V	0A	Max: 0V Min: 0V	04:(0) 12:(0) 20:(0) 28:(0)	2011-11-22 11:10
	R2:ON	D2:High				05:(0) 13:(0) 21:(0) 29:(0)	
	R3:ON	D3:High				06:(0) 14:(0) 22:(0) 30:(0)	
	R4:ON	D4:High				07:(0) 15:(0) 23:(0) 31:(0)	
7	R1:ON	D1:High	0V	0A	Max: 0V Min: 0V	00:(0) 08:(0) 16:(0) 24:(0)	2011-11-22 11:13
	R2:ON	D2:High				01:(0) 09:(0) 17:(0) 25:(0)	
	R3:ON	D3:High				02:(0) 10:(0) 18:(0) 26:(0)	
	R4:ON	D4:High				03:(0) 11:(0) 19:(0) 27:(0)	
8	R1:ON	D1:High	0V	0A	Max: 0V Min: 0V	04:(0) 12:(0) 20:(0) 28:(0)	2011-11-21 04:05
	R2:ON	D2:High				05:(0) 13:(0) 21:(0) 29:(0)	
	R3:ON	D3:High				06:(0) 14:(0) 22:(0) 30:(0)	
	R4:ON	D4:High				07:(0) 15:(0) 23:(0) 31:(0)	
11	R1:ON	D1:High	0V	0A	Max: 0V Min: 0V	00:(0) 08:(0) 16:(0) 24:(0)	2011-11-21 04:06
	R2:ON	D2:High				01:(0) 09:(0) 17:(0) 25:(0)	
	R3:ON	D3:High				02:(0) 10:(0) 18:(0) 26:(0)	
	R4:ON	D4:High				03:(0) 11:(0) 19:(0) 27:(0)	
25	R1:ON	D1:High	0V	0A	Max: 0V Min: 0V	04:(0) 12:(0) 20:(0) 28:(0)	2011-11-21 04:07
	R2:ON	D2:High				05:(0) 13:(0) 21:(0) 29:(0)	
	R3:ON	D3:High				06:(0) 14:(0) 22:(0) 30:(0)	
	R4:ON	D4:High				07:(0) 15:(0) 23:(0) 31:(0)	

5.5 TCP/IP Configuration Page

To enter the "TCP/IP Config." page, you will be asked to enter a user name and a password too. Type "meanwell" (small letters) in both the "User name" and "Password" boxes to enter this page shown as below. This user name and password cannot be changed.



Once you insert the correct user name and password, you will enter this address settings page. On this page, there are IP address, subnet mask, gateway, primary DNS, and secondary DNS that can be set and changed. For example, if the RKP-CMU1 is not in your current domain, you can revise it to your current domain by changing those IP address parameters.



6.RKP-CMU1 Monitoring Software

◎System requirements

- 1.Windows XP, Windows Vista, or Windows 7 operating system
- 2.AMD or Intel Pentium 133MHz or better based computer
- 3.USB 1.1 or higher
- 4.RKP-CMU1 monitoring software

6.1 Installation

(1)Install "Prolific USB driver" (PL2303_Prolific_DriverInstaller_v1417.exe) onto your PC if this is the first time to run this software.

Note: If there is the need for an updated driver version for your device, refer to Prolific official website.

<http://www.prolific.com.tw/eng/downloads.asp?ID=31>



(2) Install Microsoft Framework4 (dotNetFx40_Full_x86_x64.exe).

Note: If there is the need for an updated Framework4 version, refer to Microsoft website.

<http://www.microsoft.com/download/en/details.aspx?id=17851>



(3) Connect the RKP-CMU1 to your PC via a USB cable.

(4) Execute RKP-CMU1.exe.



6.2 Using RS232 for Communication with RKP-CMU1

The RKP-CMU1 not only can use USB interface for PC connection, but also can use the RS-232 interface. There is a RS-232 port (Male) on the rear of the RKP-CMU1, you can use a DB9 Female - DB9 Female cable for connection between the RKP-CMU1 and your PC. Pin description shows as below.

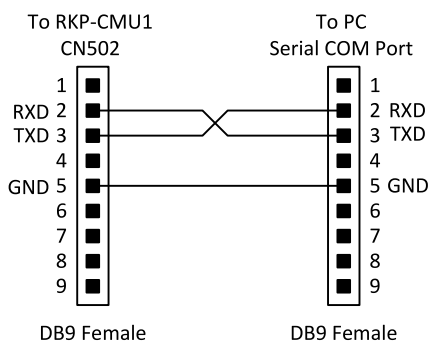

6.3 Description of RKP-CMU1 Monitoring Software

© Before running the monitoring software, please make sure the following arrangement is done correctly.

1. Interface cable is connected between your PC and the RKP-CMU1.
2. The RKP-CMU1 is powered on and ready.
3. Verify your interface settings are correct. Refer to the LCD user interface (section 4.4.6)

6.3.1 Comm. Setup Page

Once this software is running, there are some settings that must be done before accessing the RKP-CMU1.

Step 1: COM Port Setting

1. Select the correct port for your interface cable.
2. Select a proper baud rate for data transmission. (Maximum: 115.2k).

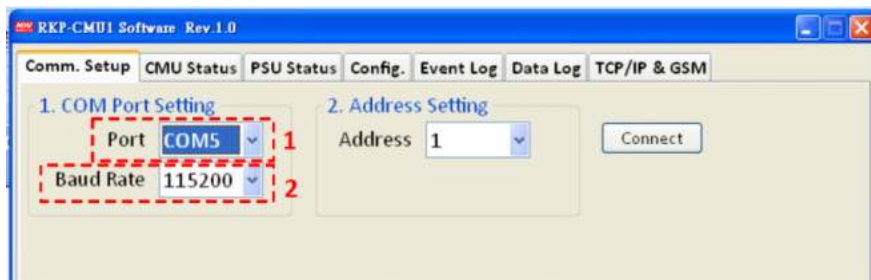

Step 2: Address Setting

Select the correct address for the RKP-CMU1. Refer to the LCD user interface, Section 4.4.9: RKP-CMU1 Address setting (Default: 1).



Step 3 : Connection

Click the "Connect" button to access the RKP-CMU1. If a connection was successfully established with the RKP-CMU1, it will display "COMx Connected". If a connection failed, it will display "Comm. fail".

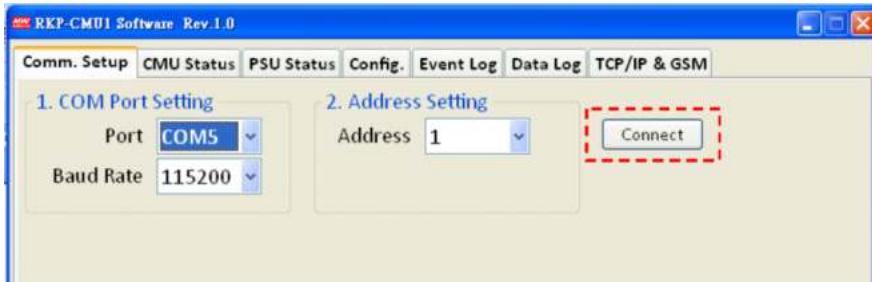

Connection was successful.

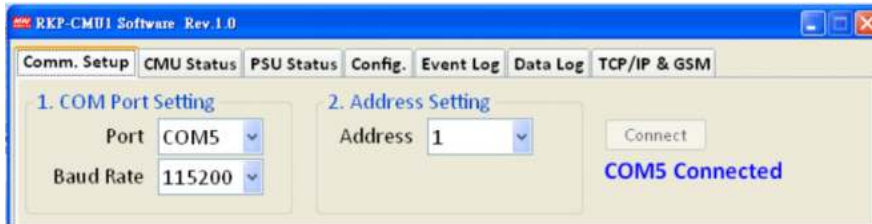

Connection failed. Make sure the interface cable is properly connected between your PC and the RKP-CMU1, and make sure the parameters you set are correct.



6.3.2 CMU Status Page

The "CMU Status" page displays information which is more important, including Bus voltage, total output current, the conditions of digital input signals, the conditions of programmable relays, the information of RKP-CMU1, PSU status, and numbers of online units.

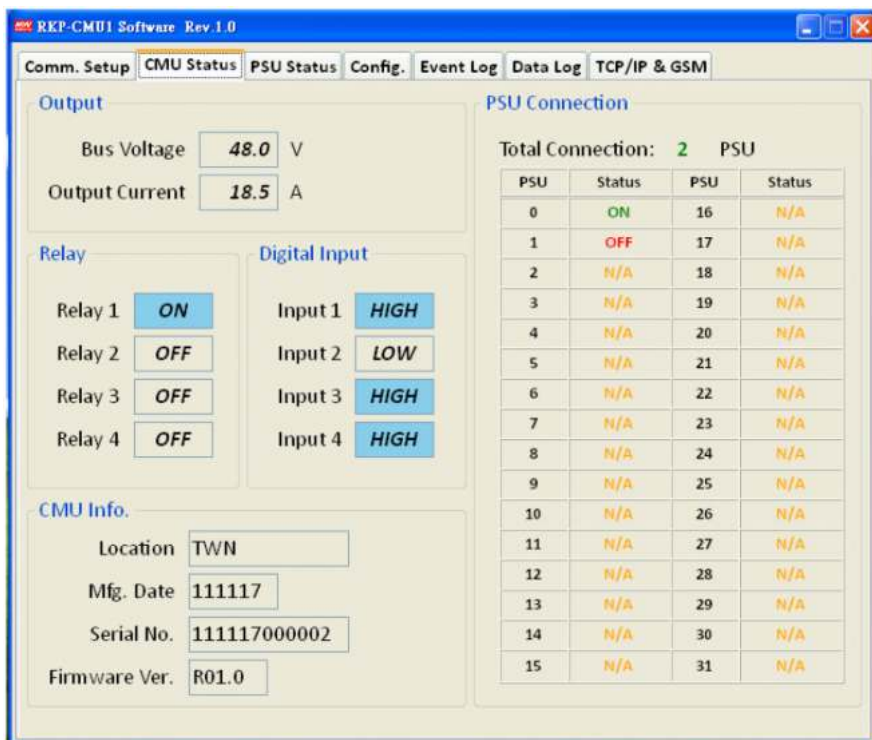

6.3.3 PSU Status Page

The "PSU Status" page displays the operating information of each PSU, including output current, internal temperature, serial number, firmware version, alarm, and status.



PSU	Current	Temperature	Serial Number	Firmware Version	Status	Alarm
0	19.0	24	110607000006	R01.4	ON	Normal
1	00.0	24	110607000006	R01.4	OFF	Normal
2	--	--	--	--	N/A	--
3	--	--	--	--	N/A	--
4	--	--	--	--	N/A	--
5	--	--	--	--	N/A	--
6	--	--	--	--	N/A	--
7	--	--	--	--	N/A	--
8	--	--	--	--	N/A	--
9	--	--	--	--	N/A	--
10	--	--	--	--	N/A	--
11	--	--	--	--	N/A	--
12	--	--	--	--	N/A	--
13	--	--	--	--	N/A	--

6.3.4 Config. Page

On this page, there are Bus voltage, PSU current, clear Event Log/Data Log, Data Log time interval setting, programmable relay setting, and PSU ON/OFF that can be set and altered.

6.3.4.1 Bus Voltage / PSU Current

If the Bus voltage/PSU current you set is not within the adjustable range, it will become invalid. Make sure the parameters that you type in are not over or less than the range as below. After settings, click the "Save" button to save your parameters.

Adjustable range of Bus voltage/ PSU current, take RCP-2000 for example, please refer to its user's manual.

Type	Bus voltage range	PSU current (Output Current) range
12V	10.5 ~ 14V	30 ~ 112A
24V	21 ~ 28V	24 ~ 89.5A
48V	42 ~ 56V	12.62 ~ 47A

Note : If the set PSU current exceeds 100A, the maximum rated current, OTP might be triggered after operating a period of time.

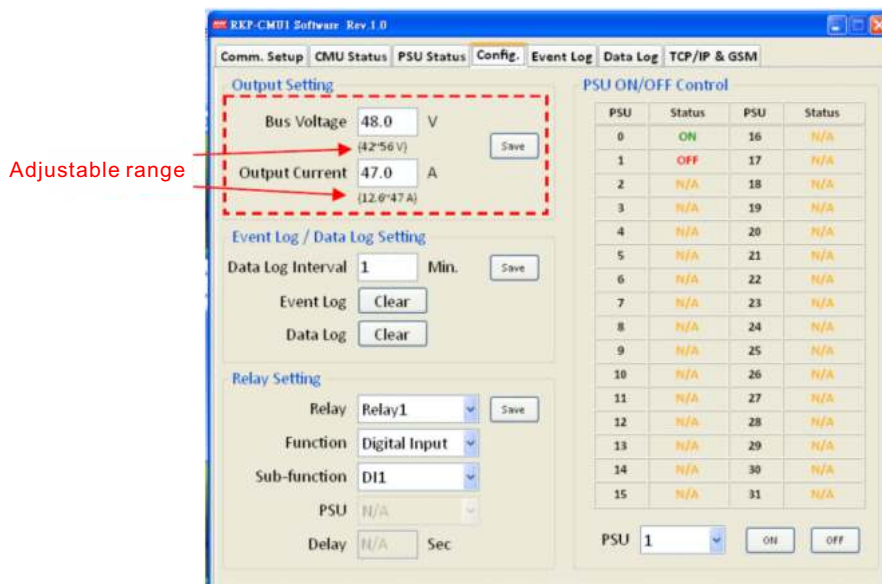

Adjustable range

6.3.4.2 Setting of Clear Event Log/Data Log and Data Log Time Interval

The "Event Log" and "Data Log" buttons are used to clear the data that Event log/Data log has stored. The "Data Log interval" is used to set the time interval from 1 to 60 minutes.



6.3.4.3 Setting of Programmable Relay

"Relay Setting" section is used to set activating conditions of the programmable relays. After setting, click the "save" button to save your setting values.

Each relay can be set for the functions below :

1. Alarm activating: Any Alarm, OVP, OLP, OTP, Short circuit, High Temp., AC Fail, Fan lock, or PMBus Error.
2. PSU ON activating: Immediately, or Delay (1~600 sec).
3. PSU OFF activating: Immediately, or Delay (1~600 sec).
4. Digital I/P activating: Control by DI1, control by DI2, control by DI3, or control by DI4.

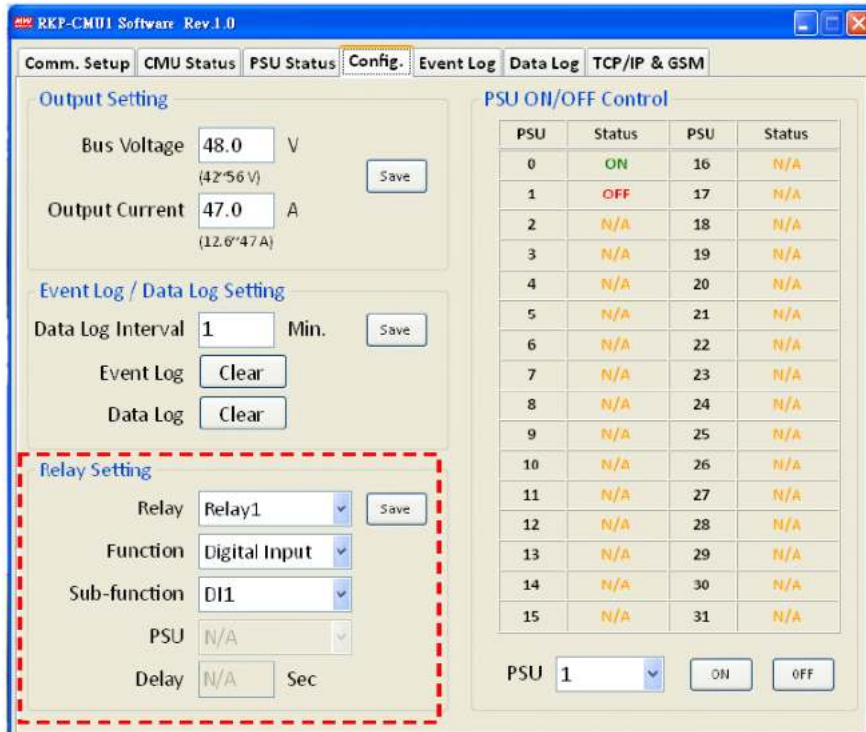

6.3.4.4 PSU ON/OFF setting

Turning a unit or all the units on/off can be done by selecting the "scroll-down list". "ON(green)" indicates "PSU ON", "OFF(red)" indicates "PSU OFF", and "N/A(orange)" indicates "unconnected". Once you have chosen a PSU, you can click the "ON" or "OFF" buttons to turn it on/off. If the status column displays "N/A(orange)", it cannot be controlled due to non-connection to the RKP-CMU1.

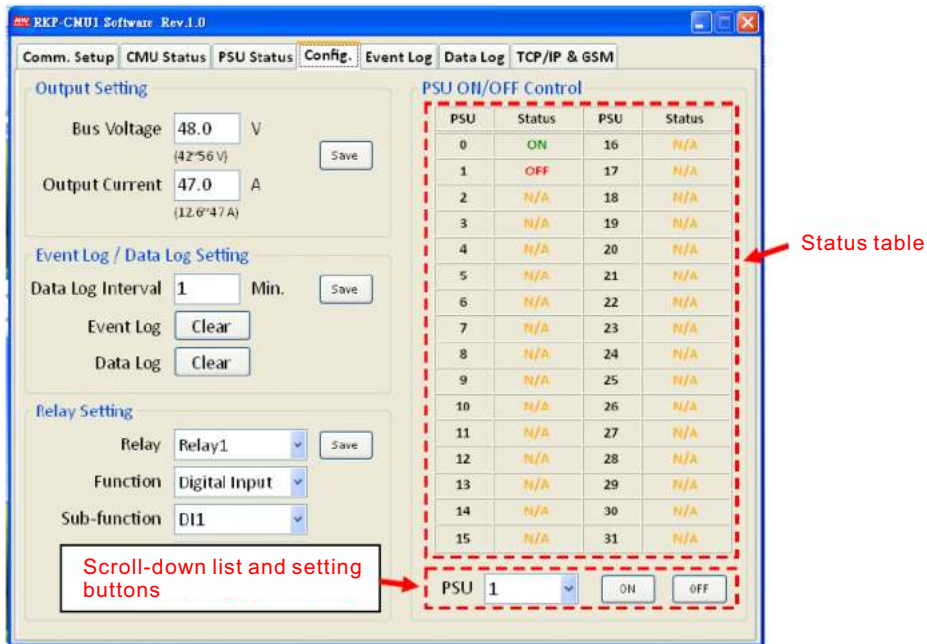

6.3.5 Event Log Page

The Event Log stores abnormal system situations when alarms occur. It is capable of saving up to 600 records, but if the stored data is over its capacity, it will overwrite the previous data, from the first record. The contents that Event Log stores include time, type of alarm, and which PSU it is. If you would like to check the data that Event Log has stored, click the "Read Log".

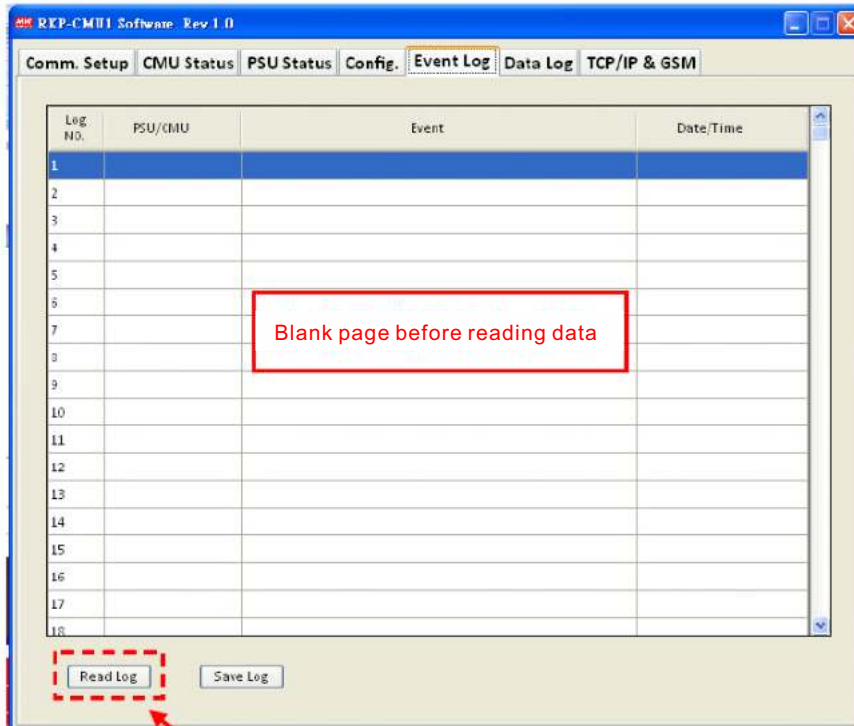

Read button

After reading from the RKP-CMU1, the data will be arranged in ascending order of Log No.. Sorting the data into other orders is also possible by clicking the column headers. Clicking the "Save Log" button can save the data onto your PC.

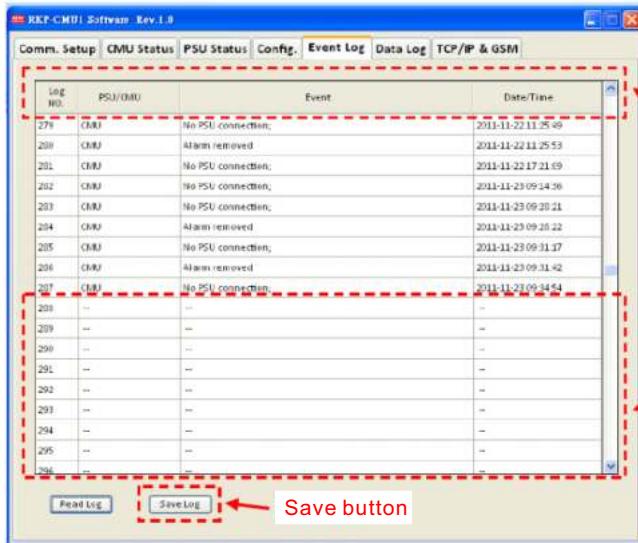

Sorting data can be done by clicking a column header

Blank area, if it is not used

Save button

6.3.6 Data Log Page

The Data Log will save operating data at regular intervals set by "Data log interval". The Data Log is capable of saving 1000 records, but if the stored data is over its capacity, it will overwrite the previous data, from the first record. The contents that Data Log stores include AC voltage, relay condition, condition of digital input signal, output voltage, total output current, each PSU's currents, and time. If you would like to check the data that Data Log has stored, click the "Read Log".

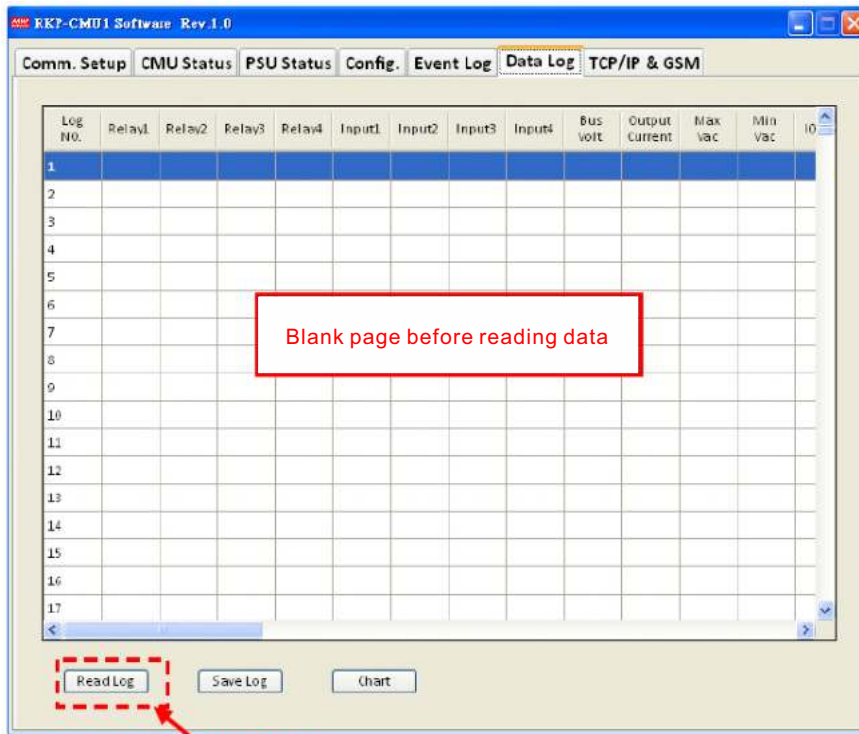

Blank page before reading data

Read button

After reading from the RKP-CMU1, the data will be arranged in ascending order of Log No.. Sorting the data into other orders is also possible by clicking the column headers. Clicking the "Save Log" button can save the data onto your PC.

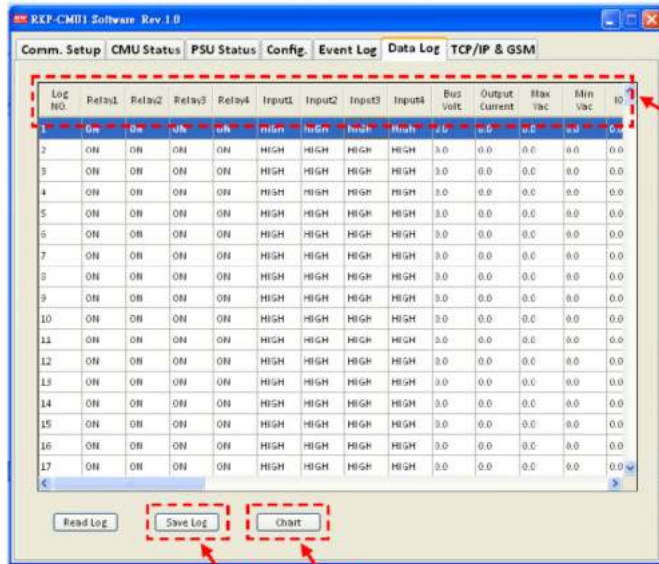

Sorting data can be done by clicking a column header

Save button Chart button

This page also offers a function that presents the Data log data in column charts by clicking the "Chart" button. Once column charts are created, tendency of the data can be seen on your PC. Except for "Vbus" and "Iout" that are fixed on the page, others like I0~I7 (PSU0~7 Iout), I8~I15 (PSU8~15 Iout), I16~I31 (PSU16~31 Iout), and Vac max/min (the maximum/minimum AC input) can be selected by the "scroll-down list".

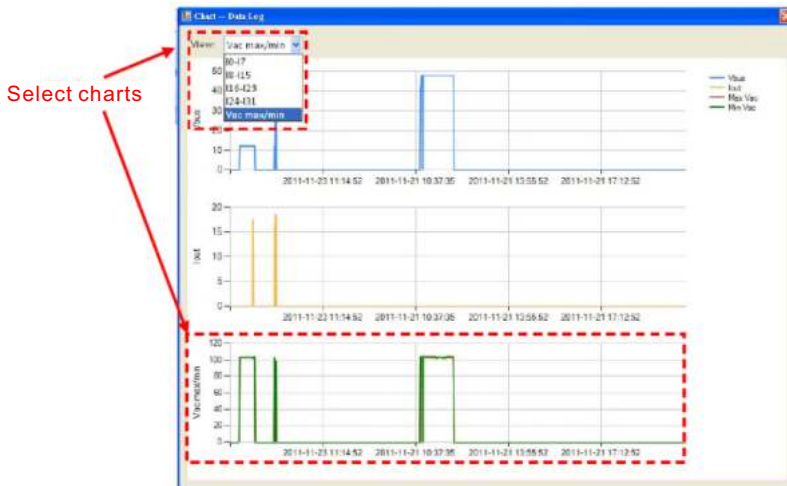

6.3.7 TCP/IP & GSM Page

This page can be split into 2 parts. One is for displaying the information of TCP/IP, including MAC address, IP address, subnet mask, and gateway. The other is for setting your GSM phone number. After typing your numbers in the column, click the "Save" button to save your phone number. "Unspecified" indicates that there's no phone number been stored yet.

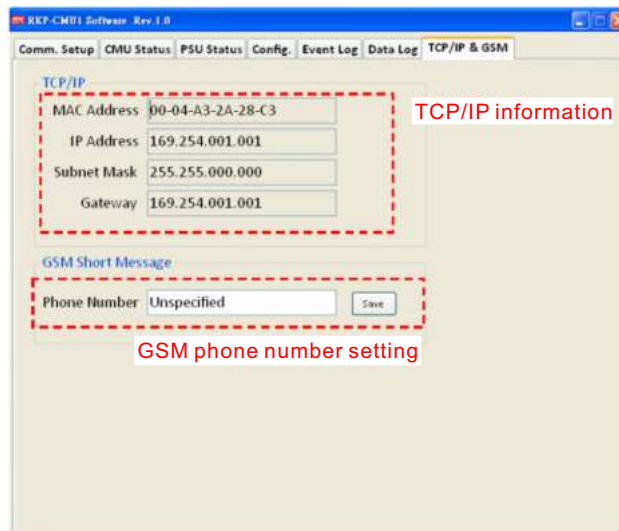

Type a GSM phone number ° (ex: 1234567890)

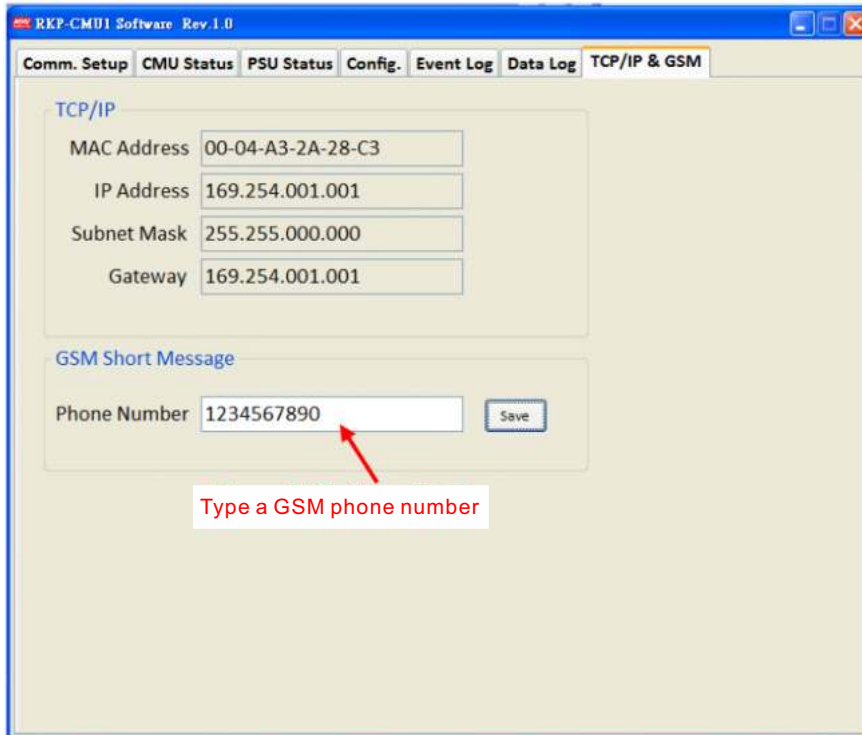

7. GSM Short Message Functions

◎ System Requirements:

1. GSM modem with antenna
2. Interface cable for GSM modem
3. SIM card

◎ Notes:

1. The RKP-CMU1 is in compliance with AT-commands for sending GSM messages. For using this function, a GSM modem equipped with those AT-commands that "Section 7.3" mentioned is needed. Refer to the product below.

Sierra Wireless, AirLink™ Programmable Modems

http://www.sierrawireless.com/productsandservices/AirLink/Programmable_Modems.aspx

2. Follow the instruction of the user manual of your GSM modem and the instruction below to properly set the connection between your GSM modem and the RKP-CMU1. Also make sure the baud rate of the GSM modem is set at 115200bps.

7.1 Installation and Settings

- (1) Insert a SIM card into your GSM modem. Make sure that there is no PIN (Personal Identification Number) recorded in the SIM card.
- (2) After installing a GSM antenna to your GSM modem and connecting an interface cable between the RKP-CMU1 and your GSM modem, turn the GSM modem on.

The figure below shows the connection diagram for a RKP-CMU1 and a GSM modem.

DB9 Female
(Standard RS-232)

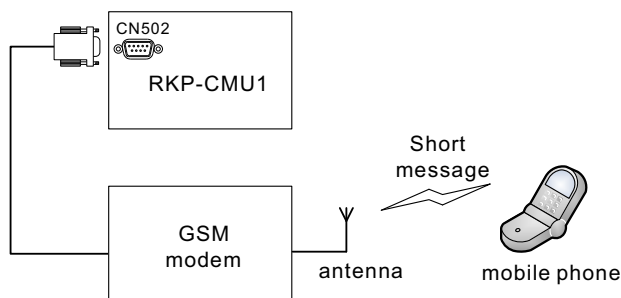

(3) Set a GSM phone number in the RKP-CMU1. Refer to "Section 6.3.7".

(4) Select "3: RS232 for GSM" in the "Communication Port Setting" through the LCD user interface. Refer to "Section 4.4.6".

7.2 Test of Sending a Short Message

(1) Turn devices on in the following order: RCP-2000, RKP-CMU1, and then GSM modem.

(2) Unplug the power of the RCP-2000.

(3) In this case, there is a "PMBus Error" alarm that will occur. Then, you should receive a text message sent by the RKP-CMU1 after a few seconds.

7.3 AT-Command List for RKP-CMU1

Command	Description
AT	Attention Command
AT+CNMI	New Message Indication
AT+CSMP	Set Text Mode Parameters
AT+CMGF	Preferred Message Format
AT+CMGS	Send Message

8. Notes on Operation

8.1 Installation Method

8.1.1 RKP-CMU1 Arrangement

- ⊙ Mount the RKP-CMU1 in a 19" rack before operating.
- ⊙ Connect the RKP-CMU1 to a JK1 port of a rack unit. Also, make sure that the JK1 ports are connected together if there are more than 2 rack units. Refer to Figure 3.3.
- ⊙ Wire up your interface cable (USB/RS232), programmable relays, and digital input signals, depending on your application.
- ⊙ Apply a 12~15 VDC to the SK100 port on the rear of the RKP-CMU1 in order to power on the unit.

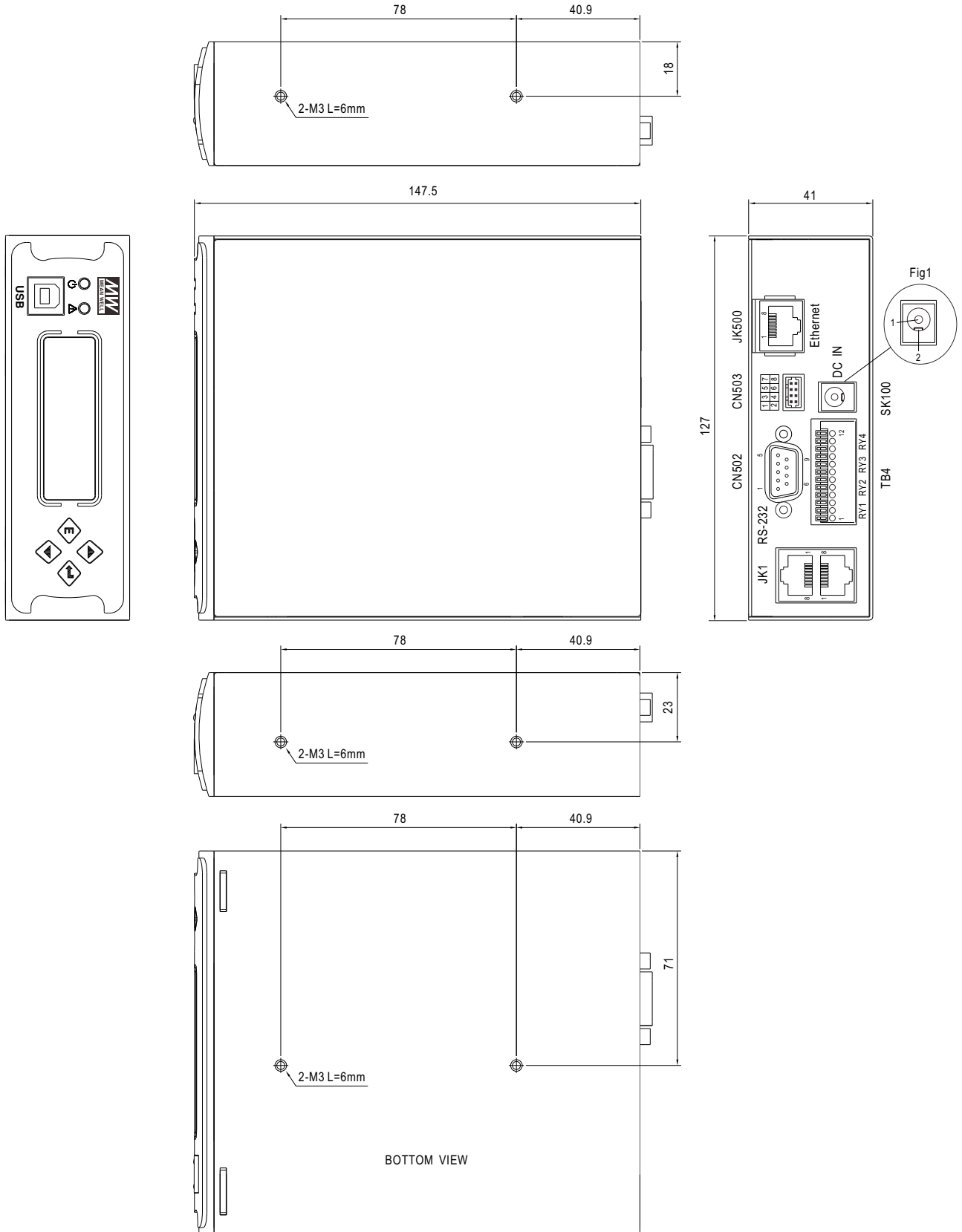

8.1.2 RKP-1U□-CMU1 Arrangement

- ⊙ Mount the rack unit in a 19" rack before operating.
- ⊙ Insert 1~2 units of RCP-2000 with the identical output voltage and current into the rack unit. Refer to Figure 8-1.
- ⊙ Assign their addresses through the 5-pole Address Switches (refer to Table 3-5). Definition of the module position: A is in the middle and B is on the left.
- ⊙ This unit is equipped with built-in DC fans and requires clearance for cooling. There should be no barriers within 10cm of the ventilation holes.
- ⊙ Connet the AC inputs of A and B units to AC source.
- ⊙ Recommended input/output wires are in Table 8-1.
- ⊙ Wire up your interface cable (USB/RS232), programmable relays, and digital input signals, depending on your application.
- ⊙ Apply a 12~15 VDC to the SK100 port on the rear of the RKP-CMU1 in order to power on RKP-CMU1.

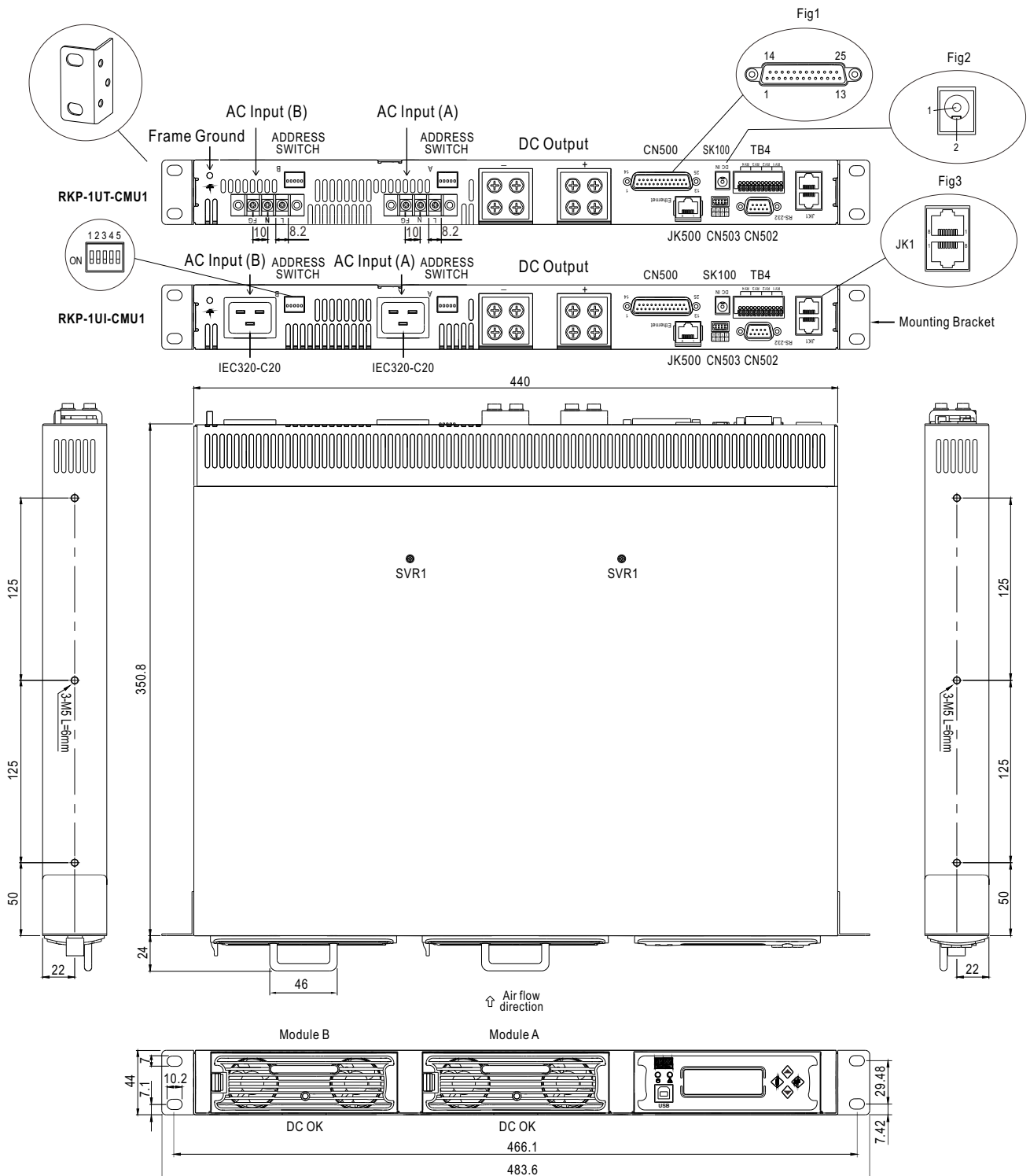

Figure 8-1 System assembly diagram of RCP series

Input/ Output	Module	Current	Minimum Cross-section of Copper Wire	Maximum Current
115VAC	1 unit	16Arms	14AWG UL1015	12A
230VAC	1 unit	10Arms	18AWG UL1015	6A
+12VDC	1 unit	100Adc	22mm ²	115A
	2 unit	200Adc	60mm ²	217A
	3 unit	300Adc	125mm ²	344A
+24VDC	1 unit	80Adc	22mm ²	115A
	2 unit	160Adc	50mm ²	190A
	3 unit	240Adc	80mm ²	240A
+48VDC	1 unit	42Adc	5.5mm ²	49A
	2 unit	84Adc	22mm ²	115A
	3 unit	126Adc	30mm ²	139A
Other commonly used wires			16AWG UL1015	8A
			12AWG UL1015	22A
			10AWG UL1015	35A
			30mm ²	139A
			50mm ²	190A
			60mm ²	217A
			80mm ²	257A
			100mm ²	298A
			125mm ²	344A
			150mm ²	395A
200mm ²	469A			
250mm ²	556A			

Table 8-1 Suggested wire selection for input/output wirings

8.2 De-rating

According to definition of the Rack Power, output over-current protection will de-rate automatically when AC input is low. Take RCP-2000 as an example as curve below, as Figure 8-2 de-rating.

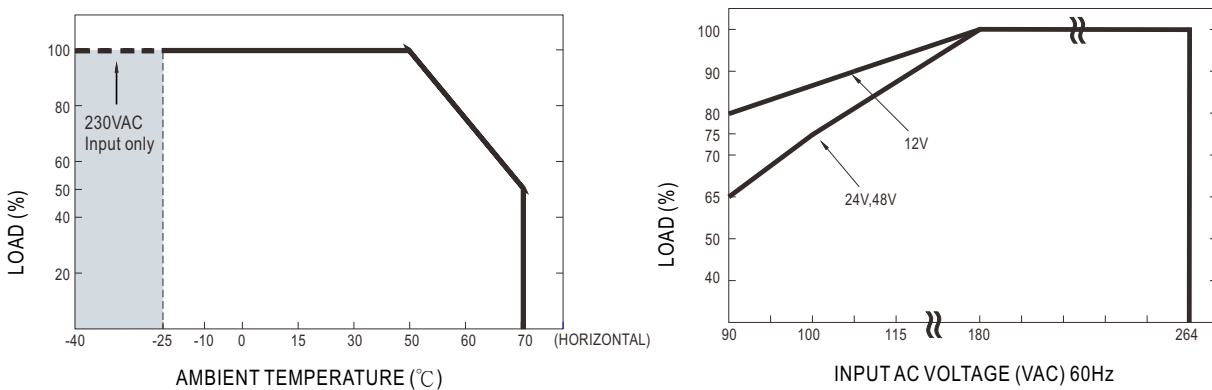

Figure 8-2 Output de-rating curves for RCP-2000 series

8.3 EMI Suppression Arrangement

EMI radiation test is greatly affected by wiring. Attaching an EMI suppressor (ferrite core) to the AC cable as close as possible to the AC inlet to reduce the noise is recommended. There are suggested components for reducing EMI radiation interference including TDK HF70RU26*29*13S, NEC ESD-SR-250H, and EROCORE FH29.7*13*25.9.

When using a RJ-45 cable as your interface cable, it might be needed to attach an EMI suppressor (ferrite core) to the cable as close as possible to the Ethernet connector (JK1) to reduce EMI radiation interference. There are TDK ZCAT2032-0930, NEC ESD-SR-160, and EROCORE FH 28x9x16 available for that purpose.

8.4 Warranty

Three years of global warranty is provided for RCP 2000 series/ RKP-CMU1 under normal operation. Please do not change any component or modify the unit by yourself or MEAN WELL may reserve the right not to provide the complete warranty service.