

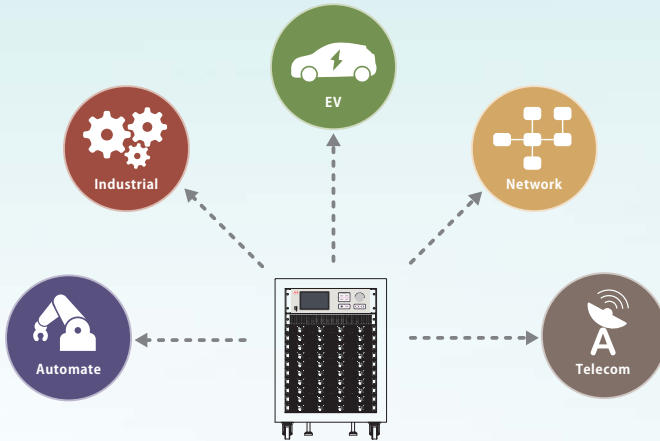

System Power - Power Management Installation manual



System Power Solution

• *Integration on power and power management system*

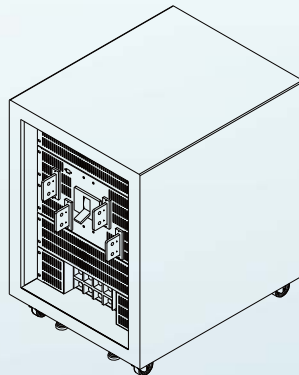



Directory

0.About Installation Manual	1
1.Safety Guidelines	2
2. Installation	3
2.1 System Cabinet Information	3
2.2 System Power Assembly	4
2.3 System Installation	4
3.Communication Control	13
4.Installation Examples	14
4.1 15U-1U-NCP-128K	14
4.2 22U-2U-SHP-240K	18
5.Environmental declaration information	21
A. Appendix	21

0.About Installation Manual

- This system power installation manual includes guideline for installing system cabinet.
- Safety warning symbol in-use.

 Warning Sign: Used to indicate a risk of death or serious injury.

 Attention Sign: Used to indicate the danger of damage to the power supply or components.

 Electric Shock Sign: Used to indicate the risk of electric shock.

 High Temperature Warning Sign: indicates a risk of burns.

1.Safety Guidelines

- At least two persons required to install the chassis into the cabinet.
- Ensure that the working environment is less than 35°C (95°F).
- Please do not obstruct any heat sink. At least 15 cm (6 in.) is required for smooth ventilation.
- Do not leave open space above or below the system power supply in the cabinet. To avoid damaging the power supply element, install the baffle in the open space to help the air circulation inside the cabinet.
- Use the door with holes to install the system power supply inside the cabinet.
- Install the device or system power supply from the bottom of the cabinet upward.
- Install heavy equipment only at the bottom of the cabinet.
- Install only one device or system power supply at a time.
- Remove the cabinet door or side cover temporarily to facilitate installation.
- The system power supply must be grounded.
- When installing multiple system power supplies in a cabinet, ensure that the input cable diameter is sufficient to bear the energy.



≥ 18KG (39.7 lbs)



≥ 32KG (70.5 lbs)



≥ 55KG (121.2 lbs)

2.Installation

2.1 System Cabinet Information

Models	W	D	H
15U	600	750	912
22U	600	750	1224
30U	600	750	1579
35U	600	750	1801
42U	600	750	2112

Unit : mm

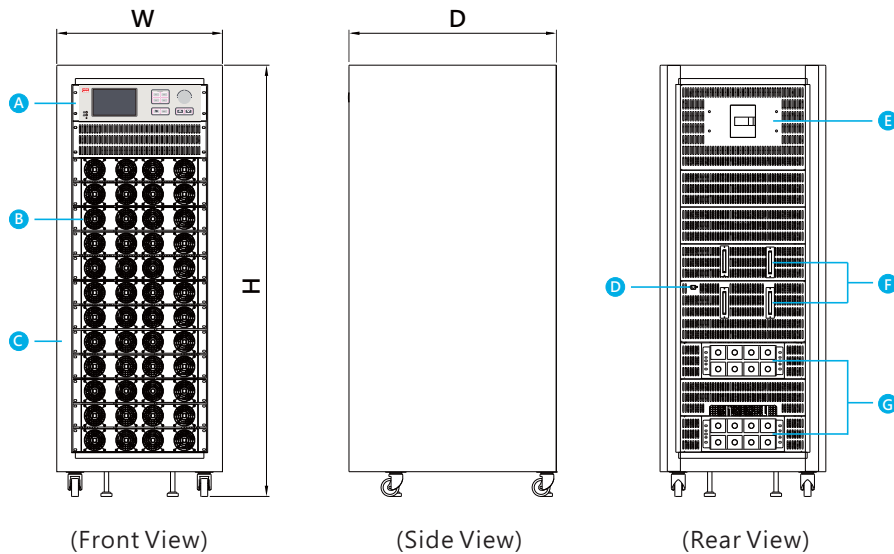

Item	Description	Item	Description
A	CMU2 Smart Controller	E	AC input circuit breaker
B	Power supply	F	DC output terminal
C	Chassis	G	AC input terminal
D	RJ-45 port		

2.2 System Power Assembly

Please understand the required wattage before assembly. If in doubt, please consult with Mean Well engineers.

2.3 System Installation

2.3.1 Pre-installation (Rack Power)

2.3.1.1 NCP-3200 series

Before installing a system cabinet, assemble the following DHP-1U-B rack to facilitate subsequent steps.

Items	Quantity *N (N is the number of units)
DHP-1UT-B	1*N
NCP-3200	4*N
Lock accessory	2*N
F4*5 Screws	6*N
Input connection fittings (1GG2FAP-014)	2*N

a. To install the left and right lock accessories, please set the torque of the electric driver to 8kgf-cm.

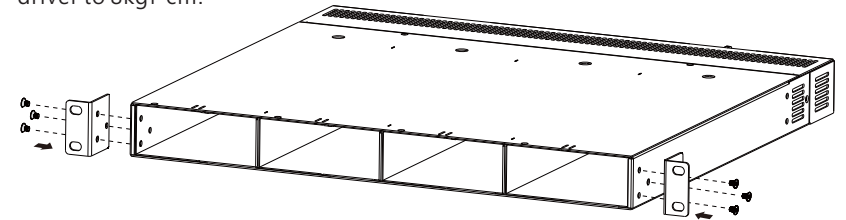

b. Install the input link plate (1GG2FAP-014) at the rear of rack. Please set the torque of the motor driver to 6kgf-cm.

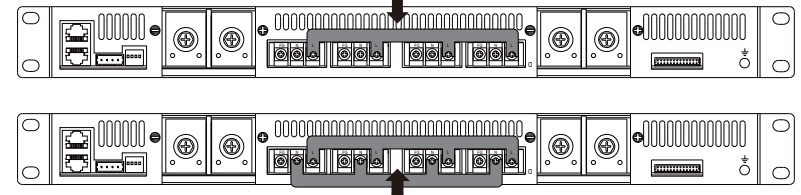

c. Place the NCP-3200 PSU in rack.

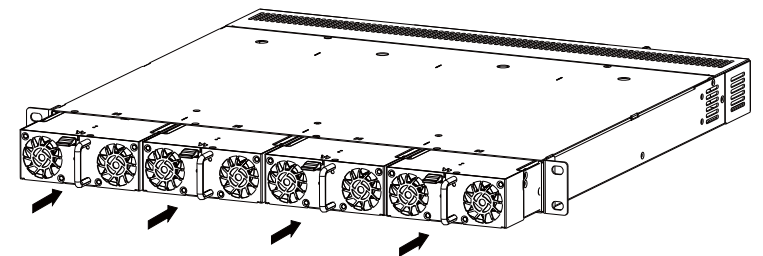

- Standalone plug-in operation: Hold the standalone handle and insert the standalone unit into the chassis.

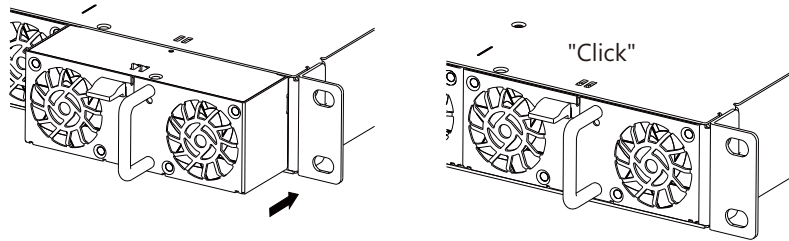

Figure 3-1 NCP-3200 Plug-in Diagram

- Standalone pull-out operation: First, fix the shrapnel according to the standalone panel (as shown in Figure 3-2), and then do the standalone pull-out action.

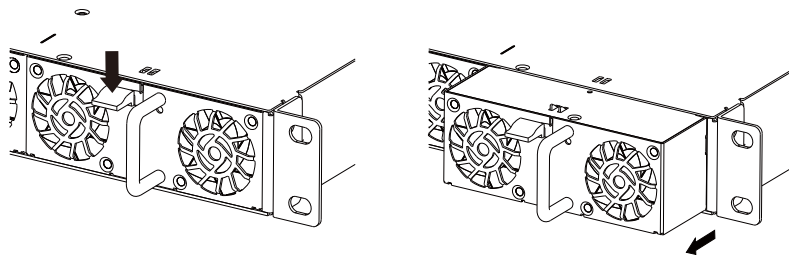
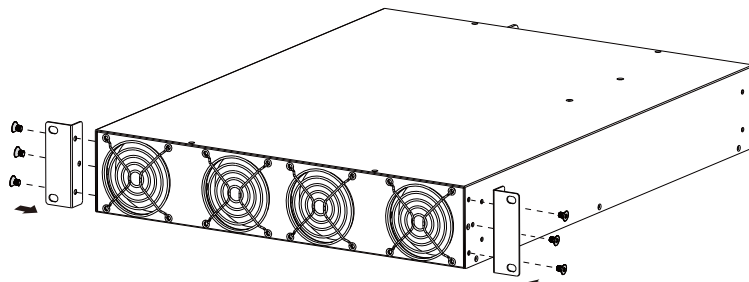

Figure 3-2 Removing the NCP-3200 from the chassis.

2.3.1.2 SHP-30K series

Before assembling the system cabinet, perform the following SHP-30K assembly to facilitate subsequent steps.

- To install the left and right lock accessories, please set the torque of the electric driver to 8kgf-cm.
- After installation, install the SHP-30K and push it into the cabinet.



2.3.1.3 Cabinet Assembly

- Install the left and right support brackets and lock them as follows. Please install the fixing nut first and then assemble the support frame. Please set the torque of the electric driver to 10kgf-cm.

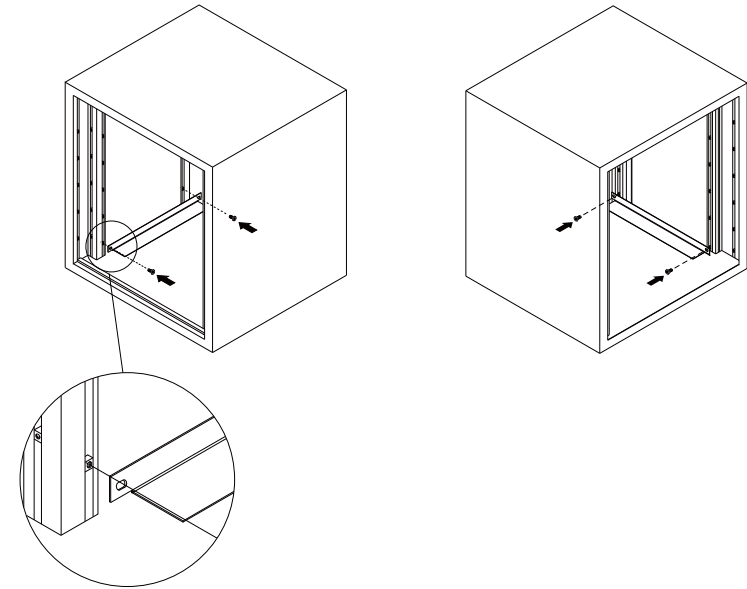

- Place the chassis to complete the locking.

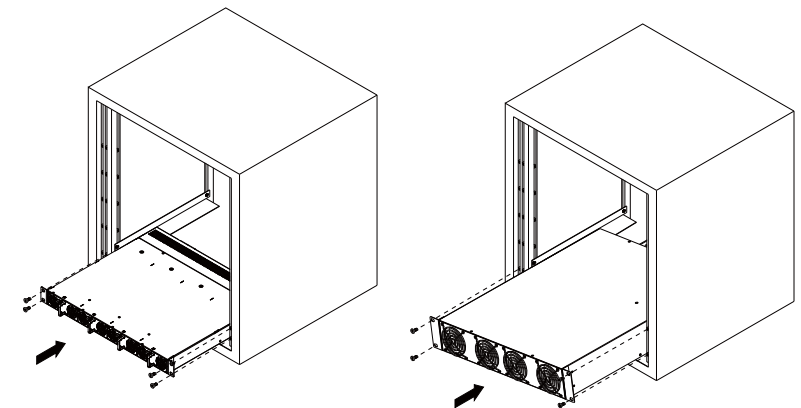

DHP-1UT-B

SHP-30K

c.If more than one unit needs to be installed, please repeat the above steps.

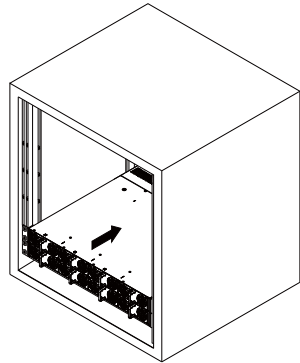

DHP-1UT-B

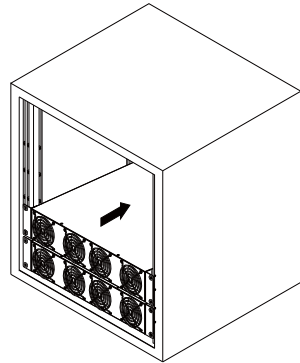

SHP-30K

Note: The support frame should be flat to the front group to avoid affecting the subsequent assembly.

d.Repeat the steps b, c, d until 10 sets of DHP-1UT-B/5 sets of SHP-30K are completed.

e.Install the CMU2C in the upper layer of the cabinet.

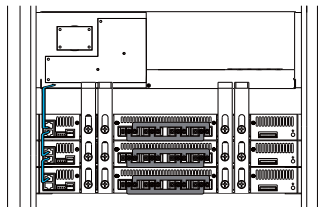

2.3.2 Output copper busbar configuration

a.Lock and attach parallel copper busbars.

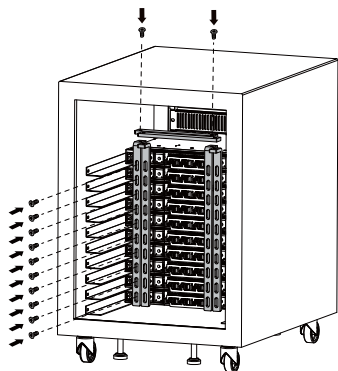

DHP-1UT-B

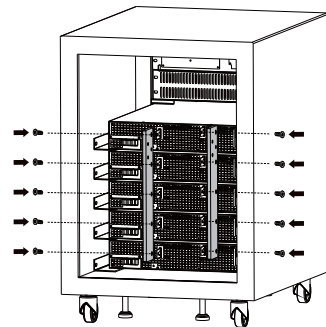

SHP-30K

2.3.2.1 DHP-1UT-B Cabinet Communication Cable Configuration

Because a single CMU2C port can only monitor a maximum of four DHP-1UT-B groups. 10 groups of DHP-1UT-B below are divided into four, three, and three groups, each controlled by different ports of the three CMU2C.

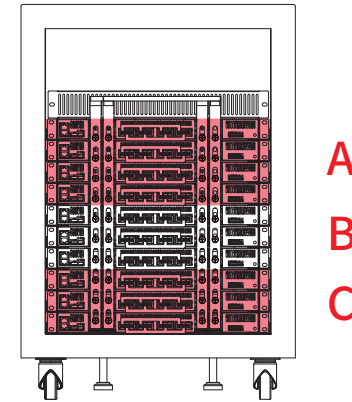

a.The chassis between each group is connected using 1FF5RJ-45-120.

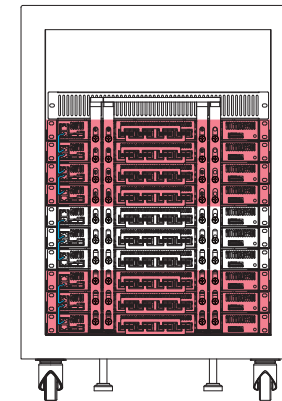

b. Connect the power pack of group A to CMU2C communication port A.

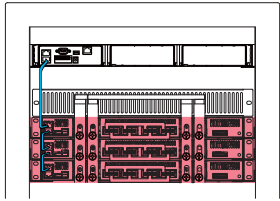

A

c. Set the address of the power group of A/B/C as follows:

Rack No.	SWA Setting				Address or ID			
	1	2	3	4	Module D	Module C	Module B	Module A
0	ON	ON	ON	ON	3	2	1	0
1	OFF	ON	ON	ON	7	6	5	4
2	ON	OFF	ON	ON	11	10	9	8
3	OFF	OFF	ON	ON	15	14	13	12
4	ON	ON	OFF	ON	19	18	17	16
5	OFF	ON	OFF	ON	23	22	21	20
6	ON	OFF	OFF	ON	27	26	25	24
7	OFF	OFF	OFF	ON	31	30	29	28
8	ON	ON	ON	OFF	35	34	33	32

d. Connect the power pack of group B to CMU2C communication port B.



A

B

e. Connect the power pack of Group C to CMU2C communication port C.

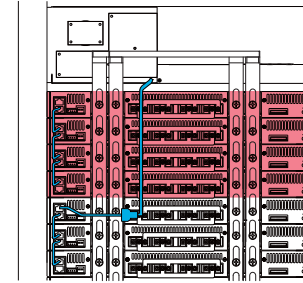

A

B

f. Connect the power pack of Group C to the CMU2C C port, this step is not error-free.

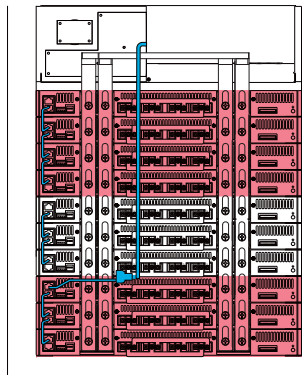

A

B

C

2.3.2.2 SHP-30K Chassis Communication Cable Configuration

- Use 1FF515U-2U-150K to connect all SHP-30Ks to CMU2.
- Set the power address as follows:

Rack No.	SWA Setting			
	1	2	3	4
0	ON	ON	ON	ON
1	OFF	ON	ON	ON
2	ON	OFF	ON	ON
3	OFF	OFF	ON	ON
4	ON	ON	OFF	ON

2.3.3 RST three-phase Input Adapter Panel (Rack power only)

2.3.3.1 NCP-3200+DHP-1UT-B

MEAN WELL provides an RST three-phase input mating device, which is first mated to the DHP-1UT-B input and balanced into the RST three-phase. Customers only need to mate the cables to the R, S, T input of this patch plate to complete the mating of the input power.

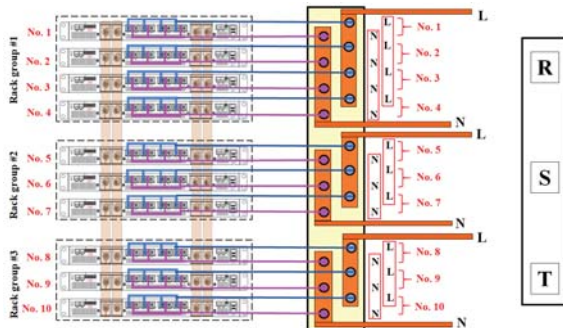

2.3.3.2 SHP-30K

RST three-phase input wiring, directly mated to the product input RST three-phase. The wire diameter must meet the current limit of the product.

2.3.4 Control system

- Before assembling the system cabinet, please perform the following RKP-CMU1 assembly to facilitate the next steps.

Item	Quantity*N (N is the number of installations)
CMU2C	1
Locking accessories	2
F4*5 screws	2*N+12
Wire 1FF5RJ-45x900 or 1FF5RJ-45x850	N

- Communication cable configuration (A, B, C) and CMU2C power connection.

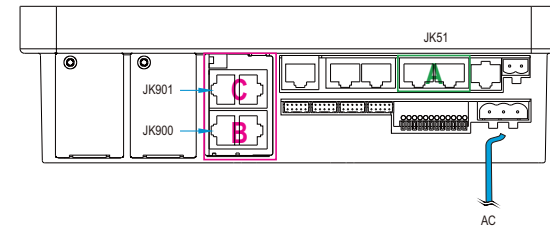

3.Communication Control

- a. MEAN WELL system power supply can be matched with MEAN WELL's self-made monitor CMU2C to achieve control and monitoring functions Please refer to the CMU2C datasheet and user manual for details. MEAN WELL system power supply NCP-3200 can support up to 16 units online at the same time. That is to say, a single CMU2C can monitor NCP-3200 *16pcs at the same time. Please refer to the following to complete the settings.
- b. The NCP-3200 unit on the bus must have its own address setting, and each unit is different.
- c. For cable link, please make sure that JK1 SDA/SCL/GND-AUX is used, or use cable 1FF5RJ-45x120 are connected to DHP cells and then connected to CMU2C as 1FF5RJ-45x900 or 1FF5RJ-45Ax850 as shown below.

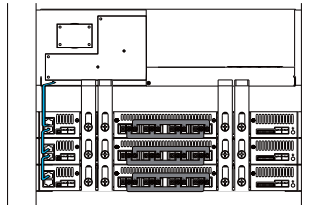

The 7-bits addressing method of NCP-3200 is defined as follows.

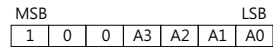

It can be set by the 4-pole DIP switch on the rear plate of the DHP-1UT-B. When the switch is placed in the ON position above it is logical "0", when it is placed in the OFF position below it is logical "1". A total of 16 different addresses can be specified for the DIP switch, and the switch position and corresponding address are shown in the following table.



Module No.	Device address				ON
	A0	A1	A2	A3	
	DIP switch position				
	1	2	3	4	
0	ON	ON	ON	ON	
1	OFF	ON	ON	ON	
2	ON	OFF	ON	ON	
3	OFF	OFF	ON	ON	
4	ON	ON	OFF	ON	
5	OFF	ON	OFF	ON	
6	ON	OFF	OFF	ON	
7	OFF	OFF	OFF	ON	

Module No.	Device address				ON
	A0	A1	A2	A3	
	DIP switch position				
	1	2	3	4	
8	ON	ON	ON	OFF	
9	OFF	ON	ON	OFF	
10	ON	OFF	ON	OFF	
11	OFF	OFF	ON	OFF	
12	ON	ON	OFF	OFF	
13	OFF	ON	OFF	OFF	
14	ON	OFF	OFF	OFF	
15	OFF	OFF	OFF	OFF	

Note: One CMU2C port can only control four racks (16 NCP-3200s), and more than 16 PSUs can be connected to other ports for group control.

4.Installation Examples

4.1 15U-1U-NCP-128K

4.1.1 Installing CMU2C

- a. Install the CMU2C chassis on the top layer of the cabinet.

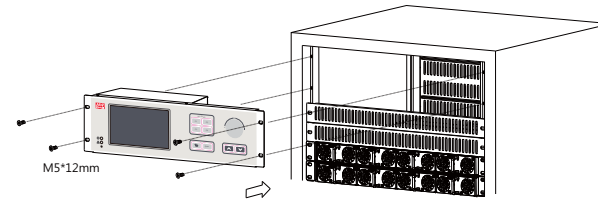

4.1.2 DHP-1UT-B Chassis Output/Wires Configuration

- a. Lock and attach parallel copper ingots.

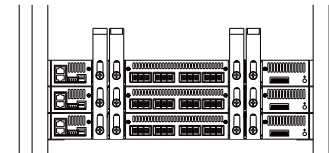

- b. Link 1FF5RJ-45x120 and 1FF5RJ-45x900 cables.

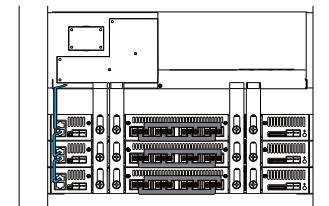

- c. Install the terminal electrical group to the lowest DHP-1UT-B chassis.

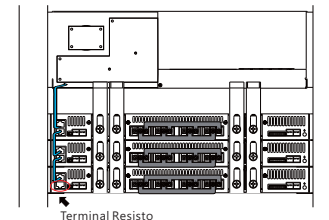

4.1.3 Communication & Control

NCP-3200

A5 - A0 can be used to select the address, which can be changed by PIN18 - PIN23 of CN1. Open circuit: Logic 1; When short circuit with -V (Singal) (PIN26): Logic 0.

Address or ID	A5	A4	A3	A2	A1	A0
0	0	0	0	0	0	0
1	0	0	0	0	0	1
2	0	0	0	0	1	0
3	0	0	0	0	1	1
4	0	0	0	1	0	0
5	0	0	0	1	0	1
6	0	0	0	1	1	0
7	0	0	0	1	1	1
8	0	0	1	0	0	0
9	0	0	1	0	0	1
10	0	0	1	0	1	0
11	0	0	1	0	1	1
12	0	0	1	1	0	0
13	0	0	1	1	0	1
14	0	0	1	1	1	0
15	0	0	1	1	1	1
16	0	1	0	0	0	0
17	0	1	0	0	0	1
18	0	1	0	0	1	0
19	0	1	0	0	1	1
20	0	1	0	1	0	0
21	0	1	0	1	0	1
22	0	1	0	1	1	0
23	0	1	0	1	1	1
24	0	1	1	0	0	0
25	0	1	1	0	0	1
26	0	1	1	0	1	0
27	0	1	1	0	1	1
28	0	1	1	1	0	0
29	0	1	1	1	0	1
30	0	1	1	1	1	0
31	0	1	1	1	1	1
32	1	0	0	0	0	0
33	1	0	0	0	0	1
34	1	0	0	0	1	0
35	1	0	0	0	1	1

Address or ID	A5	A4	A3	A2	A1	A0
36	1	0	0	1	0	0
37	1	0	0	1	0	1
38	1	0	0	1	1	0
39	1	0	0	1	1	1
40	1	0	1	0	0	0
41	1	0	1	0	0	1
42	1	0	1	0	1	0
43	1	0	1	0	1	1
44	1	0	1	1	0	0
45	1	0	1	1	0	1
46	1	0	1	1	1	0
47	1	0	1	1	1	1
48	1	1	0	0	0	0
49	1	1	0	0	0	1
50	1	1	0	0	1	0
51	1	1	0	0	1	1
52	1	1	0	1	0	0
53	1	1	0	1	0	1
54	1	1	0	1	1	0
55	1	1	0	1	1	1
56	1	1	1	0	0	0
57	1	1	1	0	0	1
58	1	1	1	0	1	0
59	1	1	1	0	1	1
60	1	1	1	1	0	0
61	1	1	1	1	0	1
62	1	1	1	1	1	0
63	1	1	1	1	1	1

4.1.4 Cabinet Assembly

- Connect 1FF5RJ-45x900 to CMU2C A. Connect 1FF5RJ-45Ax850 to CMU2C B, C. Install terminal resistors to additional ports in CMU2C A, B, and C.

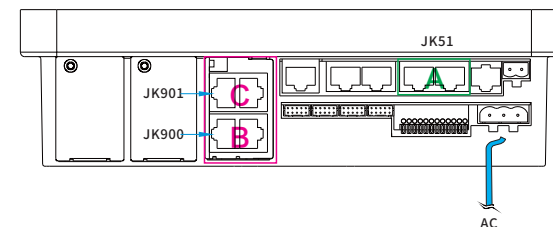

DHP-1UT-B chassis function description

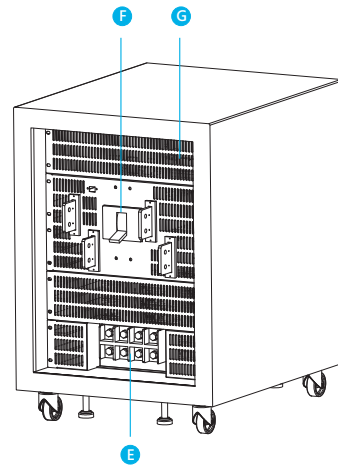
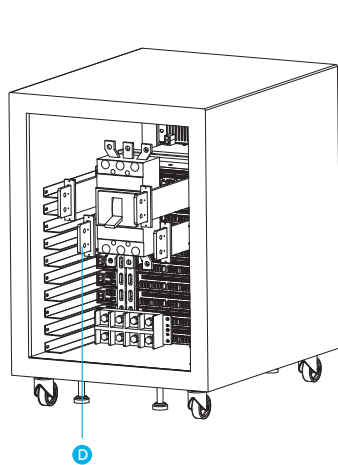
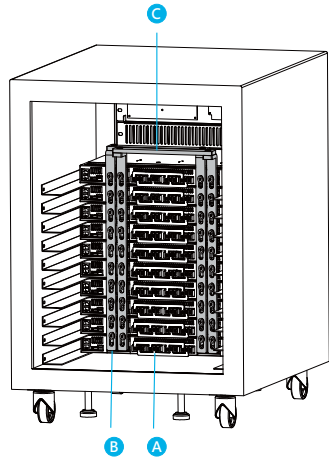

Item	Description	Item	Description
A	AC Busbar * 2	E	AC terminal blocks
B	DC Busbar A	F	Circuit breaker switch
C	DC Busbar B	G	Side panels
D	DC Busbar C		

4.2 22U-2U-SHP-240K

4.1.1 Installing CMU2C

a. Install the CMU2C chassis on the top layer of the cabinet.

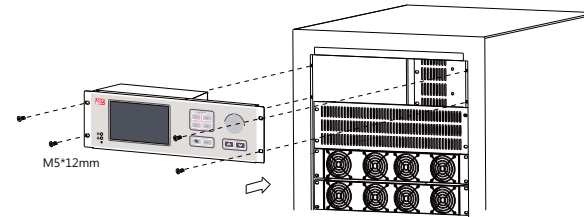

4.1.2 SHP-30K Output/Inlet and Communication Cable Configuration

a. Lock and attach parallel copper strips.

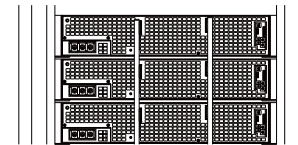

b. Link CN53 connector.

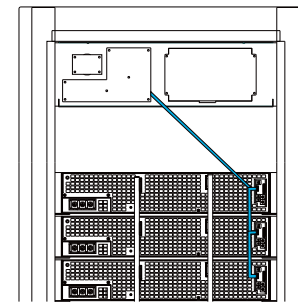

c. Install the terminal resistor.

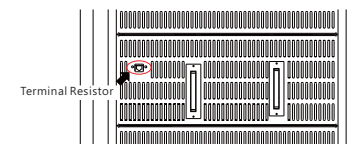

SHP-30K

Each power supply is set with a unique and unique device address, among which SW51 and SW52 can be used to select the address. (Maximum number of addresses that can be specified: 64). The device address settings are as follows:

Device Encoding	Switch Location	
	SW51	SW52
0	0	0
1	0	1
2	0	2
3	0	3
4	0	4
5	0	5
6	0	6
7	0	7
8	0	8
9	0	9
10	1	0
11	1	1
12	1	2
13	1	3
14	1	4
15	1	5
16	1	6
17	1	7
18	1	8
19	1	9
20	2	0
21	2	1
22	2	2
23	2	3
24	2	4
25	2	5
26	2	6
27	2	7
28	2	8
29	2	9
30	3	0
31	3	1

Device Encoding	Switch Location	
	SW51	SW52
32	3	2
33	3	3
34	3	4
35	3	5
36	3	6
37	3	7
38	3	8
39	3	9
40	4	0
41	4	1
42	4	2
43	4	3
44	4	4
45	4	5
46	4	6
47	4	7
48	4	8
49	4	9
50	5	0
51	5	1
52	5	2
53	5	3
54	5	4
55	5	5
56	5	6
57	5	7
58	5	8
59	5	9
60	6	0
61	6	1
62	6	2
63	6	3

SHP-30K chassis function description

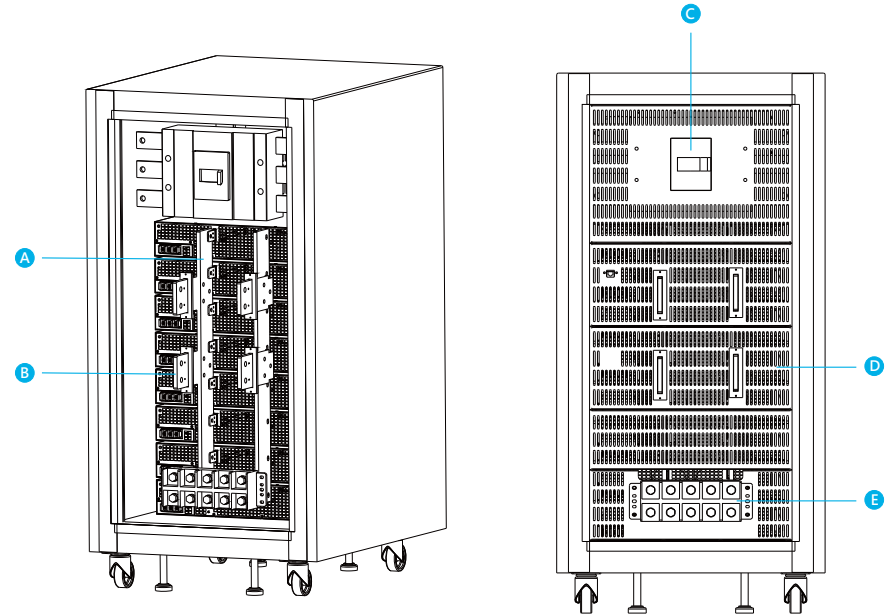

Item	Description	Item	Description
A	DC busbar A *2	D	Side panels
B	DC busbar B *4	E	AC terminal blocks
C	AC Break Switch		

5.Environmental declaration information

https://www.meanwell.com//Upload/PDF/RoHS_PFOS.pdf



https://www.meanwell.com//Upload/PDF/REACH_SVHC.pdf

https://www.meanwell.com//Upload/PDF/Declaration_RoHS-E.pdf

A. Appendix

A1 Accessories

A1.1 Parallel Link Accessories

Output Parallel Connection Accessory	
1GG2FAP-011	
1GG2FAP-012	
1GG2FAP-013	

A1.2 Connecting cables in parallel

1FF5RJ-45x120

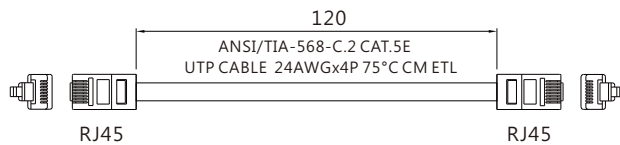

1FF5RJ-45x900

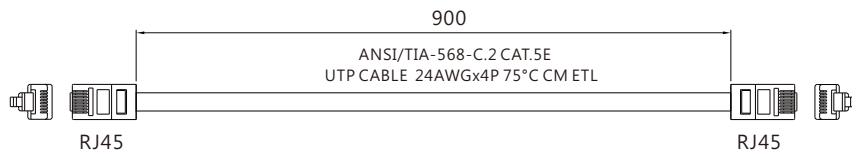

A1.3 Enter the link accessory

Input Parallel Connection Bus Link	
1GG2FAP-014	

A1.4 Support frame

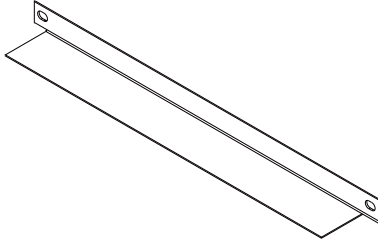
Mounting Angle	
PGG7RA27904 (2pcs/set)	

A1.5 Cabinet shelves

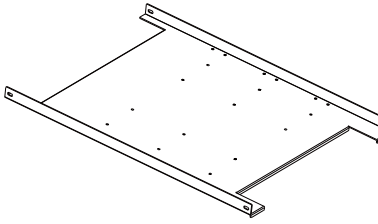
Cabinet Blank Panel	
PGG7RAF9AH01	

A1.6 Ventilation plate

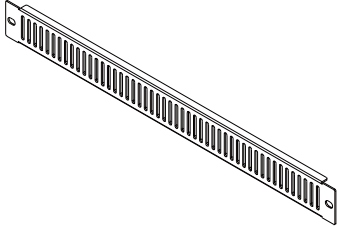
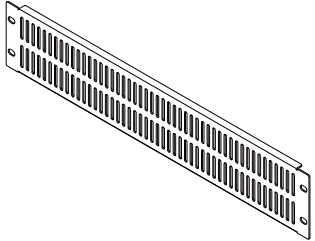
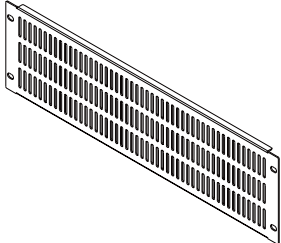
Rack Panel	
PGG7RD9AR01U (1U Rack Panel)	
PGG7RD9AR02U (2U Rack Panel)	
PGG7RD9AR03U (3U Rack Panel)	

A1.7 Blank panel

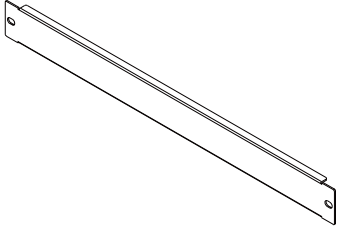
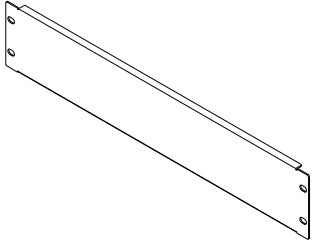
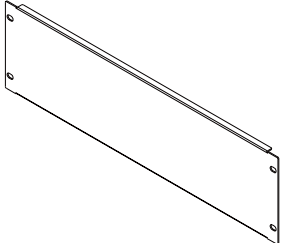
Rack Panel	
PGG7RD9AQ01U (1U Rack Panel)	
PGG7RD9AQ02U (2U Rack Panel)	
PGG7RD9AQ03U (3U Rack Panel)	

明緯企業股份有限公司

MEAN WELL ENTERPRISES CO., LTD.

248 新北市五股區五權三路28號

No.28, Wuquan 3rd Rd., Wugu Dist., New Taipei City 248, Taiwan

Tel:886-2-2299-6100 Fax:886-2-2299-6200

<http://www.meanwell.com> E-mail:info@meanwell.com