



Features

- Full power at 65~100% operation(Constant Power)
- Protection Functions: OCP,SCP,OVP,OTP
- IP67 design for indoor or outdoor installations
- Function options: output adjustable via potentiometer; 3 in 1 dimming (dim-to-off) ; DALI-2 dimming
- Typical lifetime>50000 hours and 5 years warranty
- Surge protection with 6KV/4KV
- Latest safety requirements of IEC61347/GB19510 and UL8750

Applications

- LED bay lighting
- LED stage lighting
- LED flood lighting
- LED fishing lighting
- LED horticulture lighting
- Stadium lighting
- Type “HL” for use in class I , Division 2

Description

ELGC-300 series is a 300W LED AC/DC driver featuring the constant power mode and high voltage output. ELGC-300 operates from 100~305VAC and offers models with different rated current ranging between 1300mA and 8000mA. Thanks to the high efficiency up to 94.5%, with the fanless design, the entire series is able to operate for -40°C~+85°C case temperature under free air convection. The design of metal housing and IP67 ingress protection level allows this series to fit both indoor and outdoor applications. Moreover the innovative environment-adaptive capability allows this series to reliably light on the LEDs for all kinds of application environments in almost any spots that may install LED luminaires in the world. ELGC-300 is equipped with various function options, such as dimming methodologies, so as to provide the optimal design flexibility for LED lighting system.

GTIN CODE

MW Search: <https://www.meanwell.com/serviceGTIN.aspx>

Model Encoding

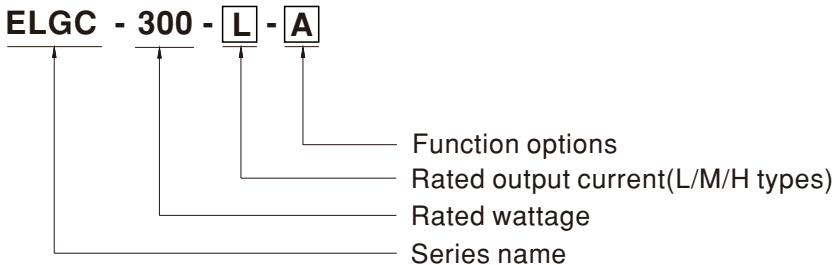

Type	IP Level	Function	Note
Blank	IP67	Blank type available by modification	By request
A	IP67	Output constant power adjustable via built-in lo potentiometer	In Stock
AB	IP67	Output constant power adjustable via built-in lo potentiometer + 3 in 1 dimming function (0~10Vdc, 10V PWM signal and resistance)	In Stock
ADA	IP67	DALI-2 control technology with lo Adjustable via built-in Potentiometer	In Stock
D2	IP67	Built-in Smart timer dimming and programmable function.	By request

SPECIFICATION

MODEL		ELGC-300-L-□	ELGC-300-M-□	ELGC-300-H-□	
OUTPUT	DEFAULT CURRENT	1400mA	2800mA	5600mA	
	RATED POWER	(200 ~ 305VAC)	301W	301W	301
		(100 ~ 180VAC)	256W	256W	256W
	CONSTANT CURRENT REGION	116 ~ 232V	58 ~ 116V	29 ~ 58V	
	FULL POWER CURRENT RANGE	1300~2000mA	2600~4000mA	5200~8000mA	
	OPEN CIRCUIT VOLTAGE (max.)	240V	120V	62V	
	CURRENT ADJ. RANGE	(200 ~ 305VAC)	650~2000mA	1300~4000mA	2600~8000mA
		(100 ~ 180VAC)	650~1700mA	1300~3400mA	2600~6800mA
	CURRENT RIPPLE	5.0% max. @rated current			
CURRENT TOLERANCE	±5%				
SET UP TIME	Note.9	500ms/230VAC, 500ms/115VAC			
INPUT	VOLTAGE RANGE	Note.2	100 ~ 305VAC 142VDC ~ 431VDC (Please refer to "STATIC CHARACTERISTIC" and "DRIVING METHODS OF LED MODULE" section)		
	FREQUENCY RANGE	47 ~ 63Hz			
	POWER FACTOR (Typ.)	PF ≥ 0.97 / 115VAC, PF ≥ 0.95 / 230VAC, PF ≥ 0.92 / 277VAC at full load (Please refer to "Power Factor Characteristic" section)			
	TOTAL HARMONIC DISTORTION	THD < 10% (@ load ≥ 50% at 115VAC/230VAC, @load ≥ 75% at 277VAC) Please refer to "TOTAL HARMONIC DISTORTION (THD)" section			
	EFFICIENCY (Typ.)	94.5%	93.5%	92.5%	
	AC CURRENT (Typ.)	3A / 115VAC	1.6A / 230VAC	1.3A / 277VAC	
	INRUSH CURRENT(Typ.)	COLD START 45A(t _{width} =1200μs measured at 50% I _{peak}) at 230VAC; Per NEMA 410			
	MAX. NO. of PSUs on 16A CIRCUIT BREAKER	2 unit(circuit breaker of type B) / 4 units(circuit breaker of type C) at 230VAC			
	LEAKAGE CURRENT	<0.75mA / 277VAC			
	STANDBY POWER CONSUMPTION	Note.5	Standby power consumption <0.5W for AB / ADA-Type(Dimming OFF)		
PROTECTION	SHORT CIRCUIT	Constant current limiting, recovers automatically after fault condition is removed			
	OVER VOLTAGE	241 ~ 275V	121 ~ 145V	61 ~ 78V	
	OVER TEMPERATURE	T _{case} >85°C ±5°C, derate power automatically by 6%/°C max			
ENVIRONMENT	WORKING TEMP.	T _{case} =-40 ~ +85°C (Please refer to "OUTPUT LOAD vs TEMPERATURE" section)			
	MAX. CASE TEMP.	T _{case} =+85°C			
	WORKING HUMIDITY	20 ~ 95% RH non-condensing			
	STORAGE TEMP., HUMIDITY	-40 ~ +80°C, 10 ~ 95% RH non-condensing			
	TEMP. COEFFICIENT	±0.03%/°C (0 ~ 60°C)			
	VIBRATION	10 ~ 500Hz, 5G 12min./1cycle, period for 72min. each along X, Y, Z axes			
SAFETY & EMC	SAFETY STANDARDS	UL8750(type"HL"), CSA C22.2 No. 250.13-12; ENEC BS EN/EN61347-1, BS EN/EN61347-2-13 independent, BS EN/EN62384; EAC TP TC 004;GB19510.1, GB19510.14; IP67;KC61347-1,KC61347-2-13 approved; Designed refer to AS/NZS 61347 & AS/NZS 60598			
	DALI STANDARDS	Compliance to IEC62386-101,102,207 for ADA Type only			
	WITHSTAND VOLTAGE	I/P-O/P:3.75KVAC I/P-FG:2KVAC O/P-FG:1.5KVAC			
	ISOLATION RESISTANCE	I/P-O/P, I/P-FG, O/P-FG:100M Ohms / 500VDC / 25°C / 70% RH			
	EMC EMISSION	Compliance to BS EN/EN55015, BS EN/EN61000-3-2 Class C (@ load ≥ 50%); BS EN/EN61000-3-3;GB/T 17743,GB17625.1;KN15			
	EMC IMMUNITY	Compliance to BS EN/EN61000-4-2,3,4,5,6,8,11, BS EN/EN61547, light industry level (surge immunity Line-Earth 6KV, Line-Line 4KV);KN61547			
OTHERS	MTBF	1637.5K hrs min.	Telcordia SR-332 (Bellcore) ;170.1K hrs min.	MIL-HDBK-217F (25°C)	
	LIFETIME	Note.4	50000 hrs min.		
	DIMENSION	246*77*39.5mm (L*W*H)			
	PACKING	1.45Kg;9pcs/14Kg/0.76CUFT			
NOTE	<p>1. All parameters NOT specially mentioned are measured at 230VAC input, rated current and 25°C of ambient temperature.</p> <p>2. De-rating may be needed under low input voltages. Please refer to "STATIC CHARACTERISTIC" sections for details.</p> <p>3. The driver is considered as a component that will be operated in combination with final equipment. Since EMC performance will be affected by the complete installation, the final equipment manufacturers must re-qualify EMC Directive on the complete installation again. (as available on https://www.meanwell.com/Upload/PDF/EMI_statement_en.pdf)</p> <p>4. This series meets the typical life expectancy >50,000 hours of operation when T_{case} particularly (C) point (or TMP, per DLC), is 70°C or less.</p> <p>5. To fulfill requirements of the latest ErP regulation for lighting fixture, this LED driver can only be used behind a switch without permanently connected to the mains.</p> <p>6. Please refer to the warranty statement on MEAN WELL's website at http://www.meanwell.com</p> <p>7. The ambient temperature derating of 3.5°C/1000m with fanless models and of 5°C/1000m with fan models for operating altitude higher than 2000m(6500ft).</p> <p>8. For any application note and IP water proof function installation caution, please refer our user manual before using. https://www.meanwell.com/Upload/PDF/LED_EN.pdf</p> <p>9. Based on IEC 62386-101/102 DALI power on timing and interruption regulations, the set up time needs to test with a DALI controller which can support for DALI power on function, otherwise the set up time will be higher than 0.5 second for DA type.</p> <p>10. RCM is on a voluntary basis. Non IC classification Independent LED control gear is not suitable for residential installations.</p> <p>11. Products sourced from the Americas regions may not have the ENEC/BIS/CCC/KC logo. Please contact your MEAN WELL sales for more information.</p> <p>12. For A/AB/ADA type need to consider build in using to comply with Type HL application</p> <p>※ Product Liability Disclaimer : For detailed information, please refer to https://www.meanwell.com/serviceDisclaimer.aspx</p>				

BLOCK DIAGRAM

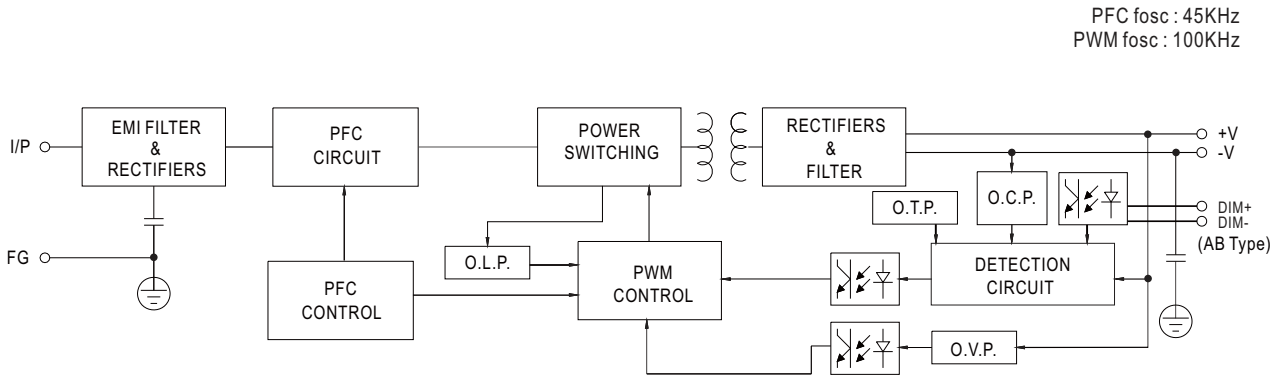

DRIVING METHODS OF LED MODULE

※ I-V Operating Area:(Red Line for AC 115V operation)

◎ ELGC-300-L

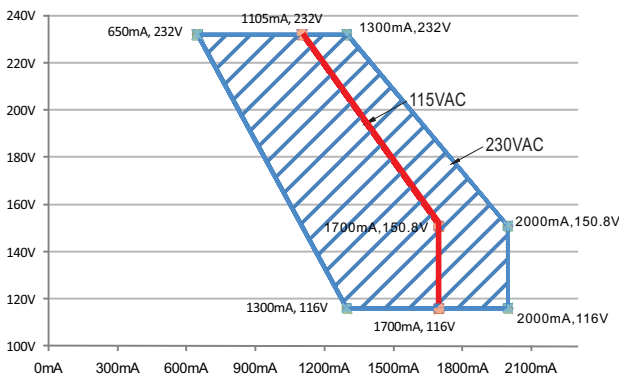

◎ ELGC-300-M

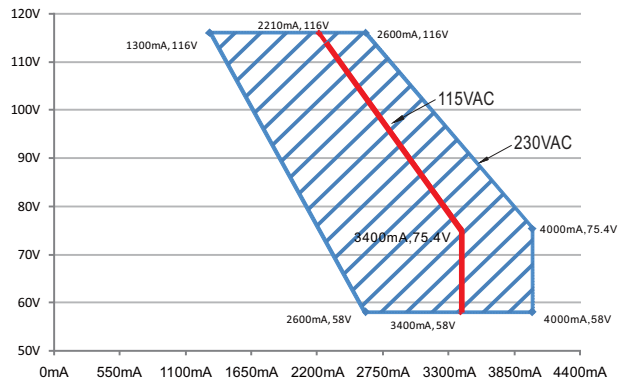

◎ ELGC-300-H

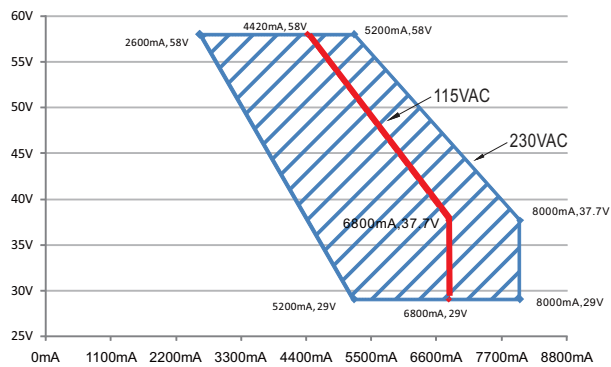

DIMMING OPERATION

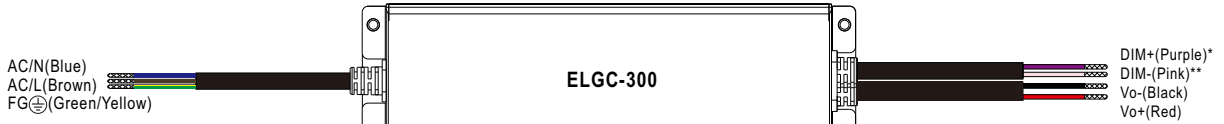

* DIM+ for AB Type
 DA+ for ADA Type
 PROG+ for D2 Type
 ** DIM- for AB Type
 DA- for ADA Type
 PROG- for D2 Type

※ **3 in 1 dimming function (for AB-Type)**

- Output constant current level can be adjusted by applying one of the three methodologies between DIM+ and DIM-: 0 ~ 10VDC, or 10V PWM signal or resistance.
- Direct connecting to LEDs is suggested. It is not suitable to be used with additional drivers.
- Dimming source current from power supply: 100 μ A (typ.)

◎ Applying additive 0 ~ 10VDC

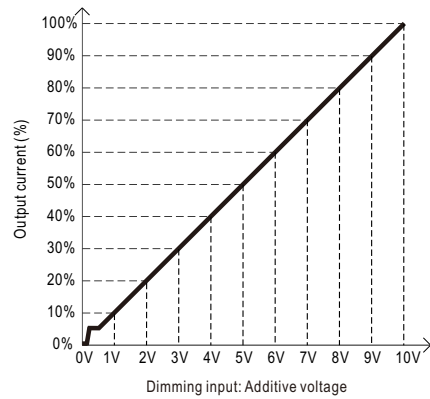
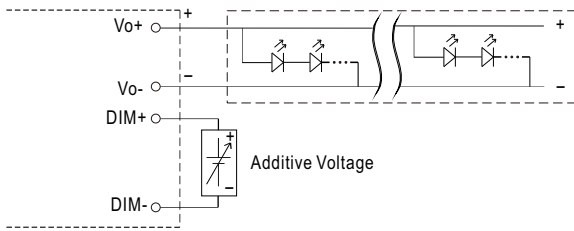

◎ Applying additive 10V PWM signal (frequency range 100Hz ~ 3KHz):

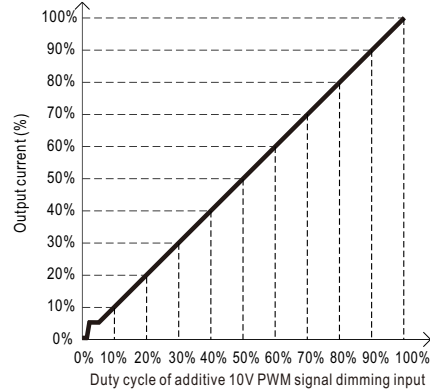
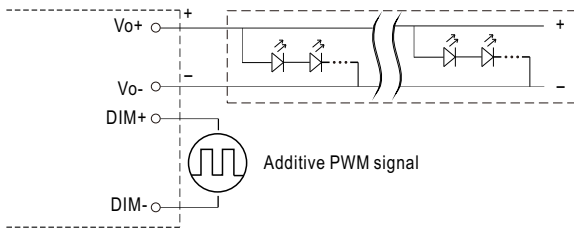

◎ Applying additive resistance:

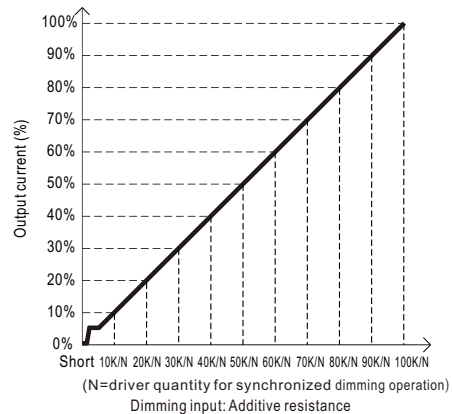
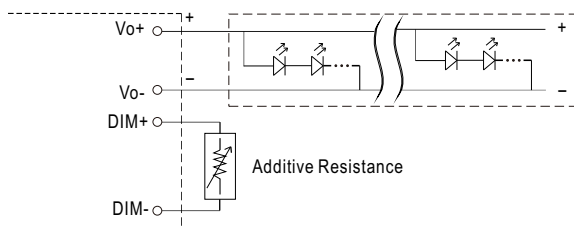

Note : 1. Min. dimming level is about 8% and the output current is not defined when 0% < I_{out} < 8%.
 2. The output current could drop down to 0% when dimming input is about 0 Ω or 0Vdc, or 10V PWM signal with 0% duty cycle.

※ **DALI Interface (primary side; for ADA-Type)**

- Apply DALI signal between DA+ and DA-.
- DALI protocol comprises 16 groups and 64 addresses.
- First step is fixed at 8% of output.

※ **Smart timer dimming function (for Dxx-Type by User definition)**

MEAN WELL Smart timer dimming primarily provides the adaptive proportion dimming profile for the output constant current level to perform up to 14 consecutive hours. 3 dimming profiles hereunder are defined accounting for the most frequently seen applications. If other options may be needed, please contact MEAN WELL for details.

Ex : ☉ D01-Type: the profile recommended for residential lighting

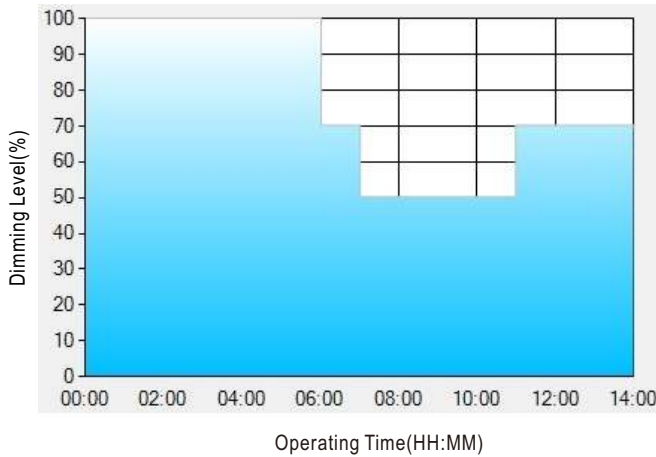

Set up for D01-Type in Smart timer dimming software program:

	T1	T2	T3	T4
TIME**	06:00	07:00	11:00	---
LEVEL**	100%	70%	50%	70%

** : TIME matches Operating Time in the diagram whereas LEVEL matches Dimming Level.

Example: If a residential lighting application adopts D01-Type, when turning on the power supply at 6:00pm, for instance:

- [1] The power supply will switch to the constant current level at 100% starting from 6:00pm.
- [2] The power supply will switch to the constant current level at 70% in turn, starting from 0:00am, which is 06:00 after the power supply turns on.
- [3] The power supply will switch to the constant current level at 50% in turn, starting from 1:00am, which is 07:00 after the power supply turns on.
- [4] The power supply will switch to the constant current level at 70% in turn, starting from 5:00am, which is 11:00 after the power supply turns on.

The constant current level remains till 8:00am, which is 14:00 after the power supply turns on.

Ex : ☉ D02-Type: the profile recommended for street lighting

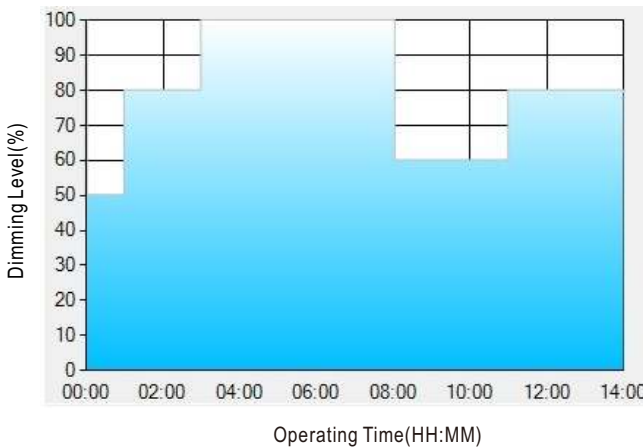

Set up for D02-Type in Smart timer dimming software program:

	T1	T2	T3	T4	T5
TIME**	01:00	03:00	8:00	11:00	---
LEVEL**	50%	80%	100%	60%	80%

** : TIME matches Operating Time in the diagram whereas LEVEL matches Dimming Level.

Example: If a street lighting application adopts D02-Type, when turning on the power supply at 5:00pm, for instance:

- [1] The power supply will switch to the constant current level at 50% starting from 5:00pm.
- [2] The power supply will switch to the constant current level at 80% in turn, starting from 6:00pm, which is 01:00 after the power supply turns on.
- [3] The power supply will switch to the constant current level at 100% in turn, starting from 8:00pm, which is 03:00 after the power supply turns on.
- [4] The power supply will switch to the constant current level at 60% in turn, starting from 1:00am, which is 08:00 after the power supply turns on.
- [5] The power supply will switch to the constant current level at 80% in turn, starting from 4:00am, which is 11:00 after the power supply turns on. The constant current level remains till 6:30am, which is 14:00 after the power supply turns on.

Ex: ☉ D03-Type: the profile recommended for tunnel lighting

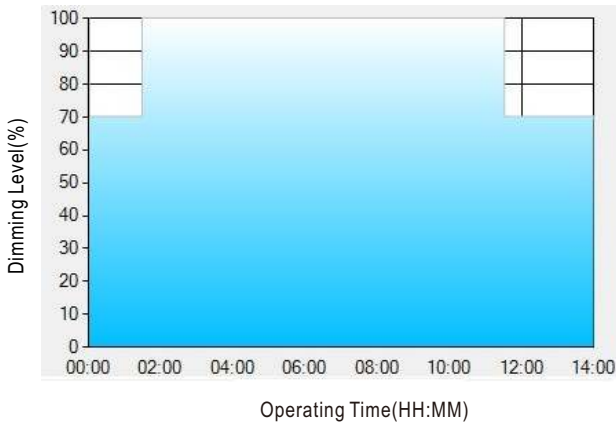

Set up for D03-Type in Smart timer dimming software program:

	T1	T2	T3
TIME**	01:30	11:00	---
LEVEL**	70%	100%	70%

** : TIME matches Operating Time in the diagram whereas LEVEL matches Dimming Level.

Example: If a tunnel lighting application adopts D03-Type, when turning on the power supply at 4:30pm, for instance:

[1] The power supply will switch to the constant current level at 70% starting from 4:30pm.

[2] The power supply will switch to the constant current level at 100% in turn, starting from 6:00pm, which is 01:30 after the power supply turns on.

[3] The power supply will switch to the constant current level at 70% in turn, starting from 5:00am, which is 11:00 after the power supply turns on.

The constant current level remains till 6:30am, which is 14:00 after the power supply turns on.

OUTPUT LOAD vs TEMPERATURE

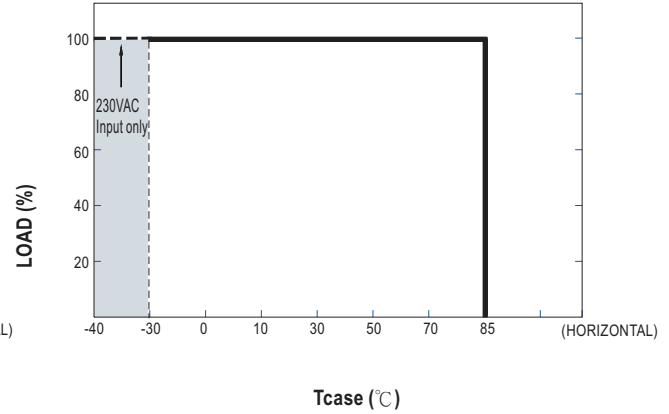
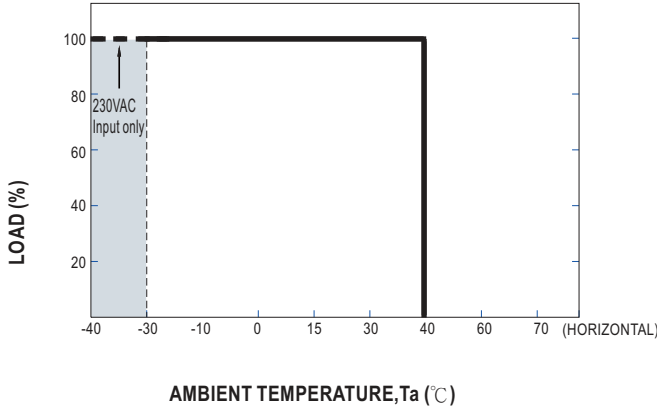

⊙ $T_{case} > 85^\circ\text{C} \pm 5^\circ\text{C}$ derate power automatically

STATIC CHARACTERISTIC

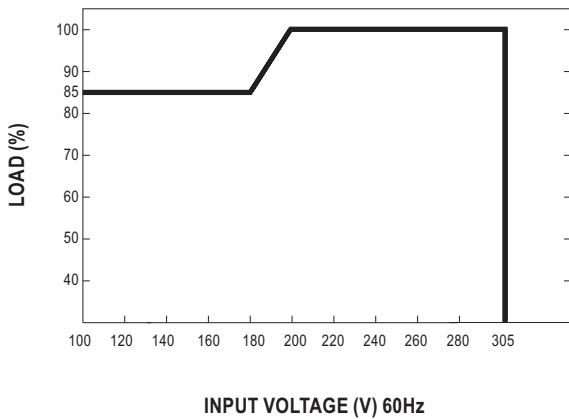

POWER FACTOR (PF) CHARACTERISTIC

※ T_{case} at 75°C

Constant Current Mode

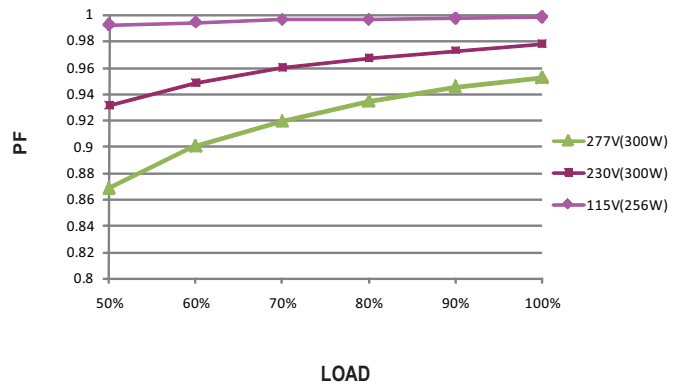

TOTAL HARMONIC DISTORTION (THD)

※ ELGC-300-L Model, T_{case} at 75°C

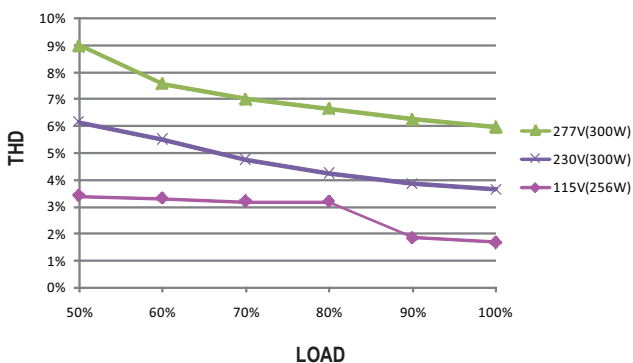

EFFICIENCY vs LOAD

ELGC-300 series possess superior working efficiency that up to 94.5% can be reached in field applications.

※ ELGC-300-L Model, T_{case} at 75°C

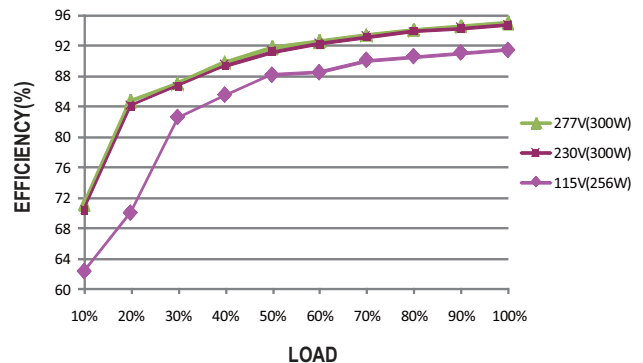



■ LIFE TIME

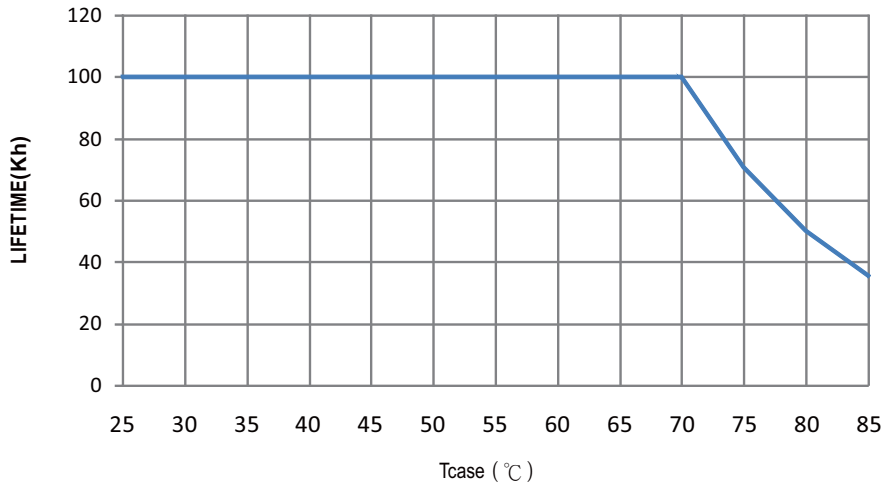

MECHANICAL SPECIFICATION

Case No.:266A Unit:mm Tolerance:±1

※ A-Type

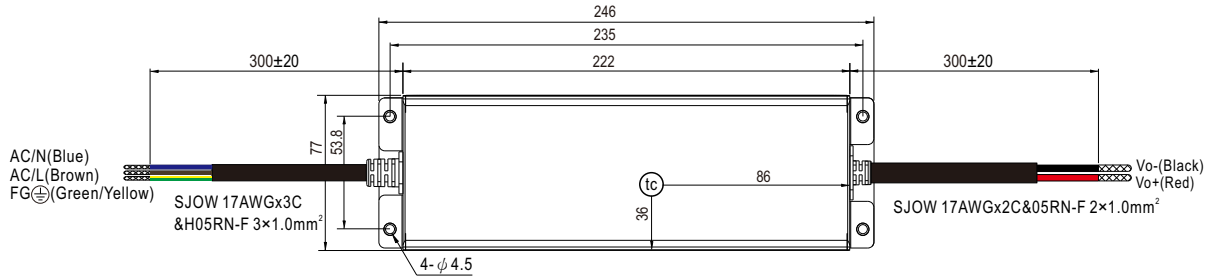

• (tc) : Max. Case Temperature

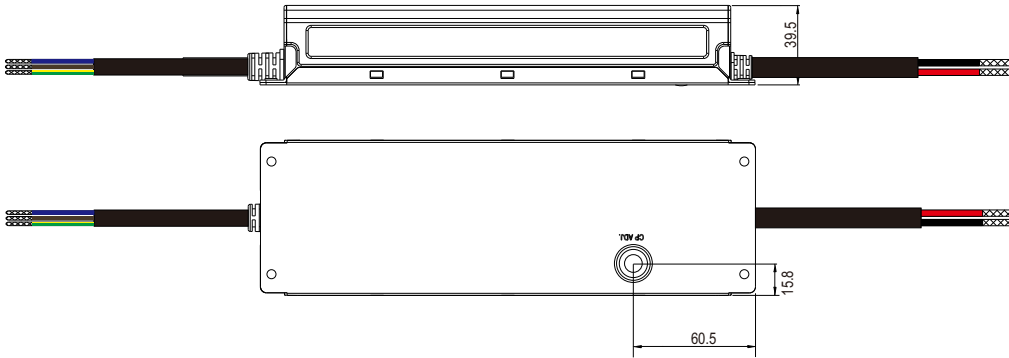

※ AB-Type

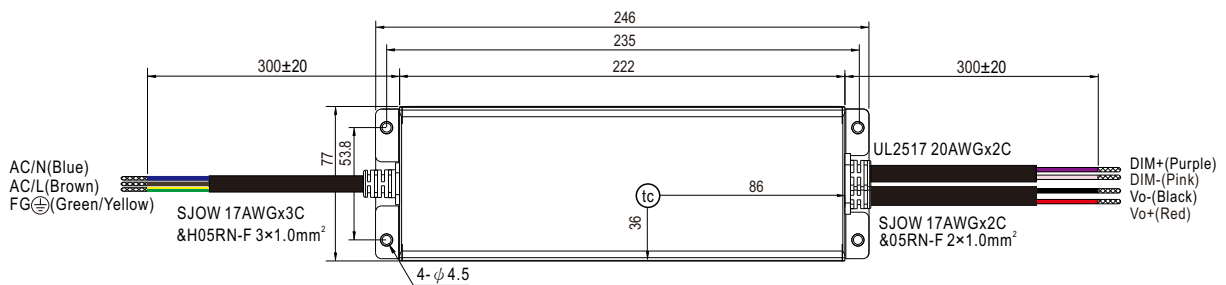

• (tc) : Max. Case Temperature

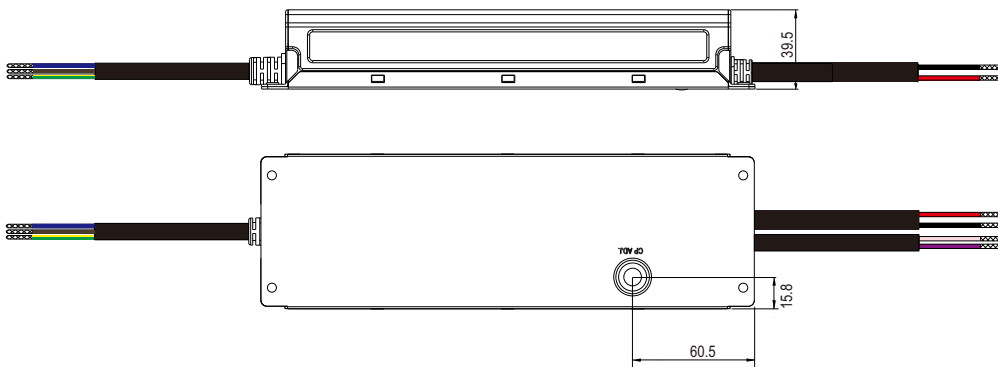

※ D2-Type

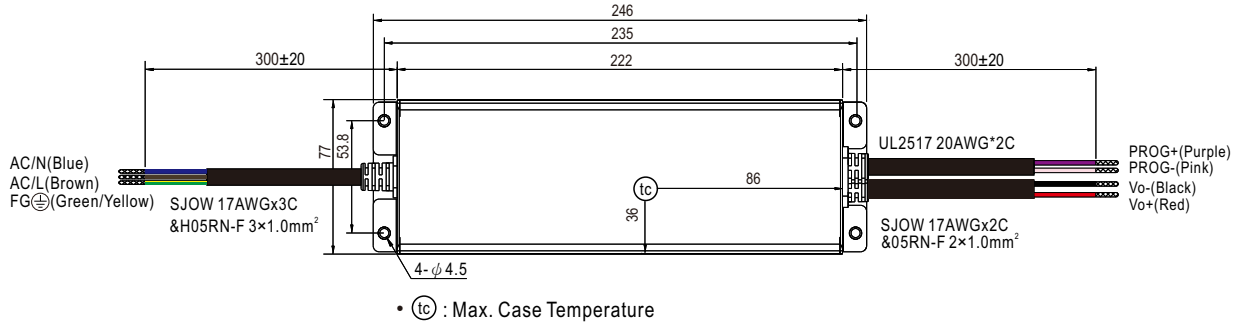

※ ADA-Type

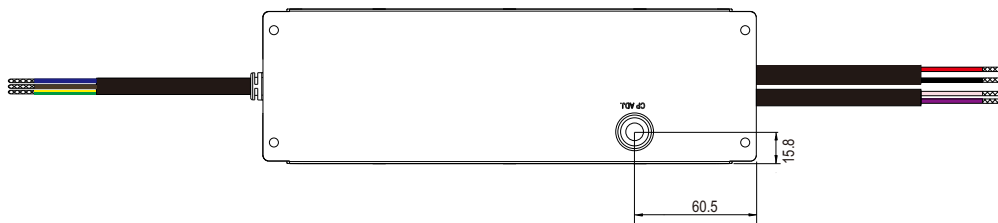
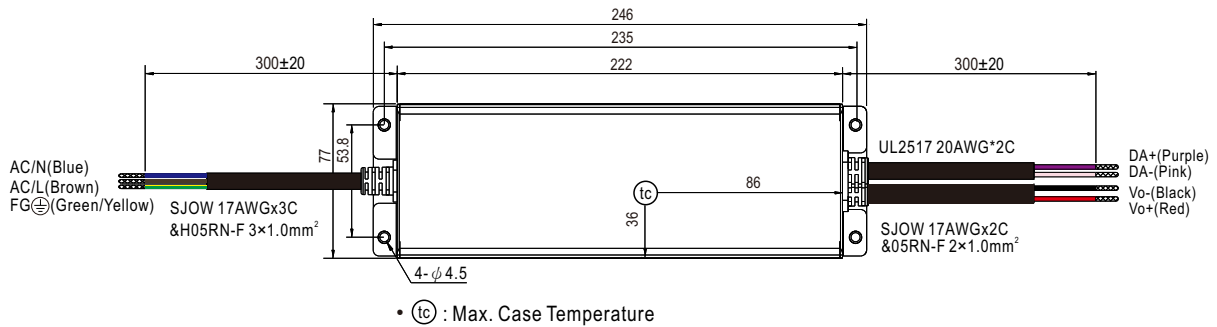

■ Recommend Mounting Direction

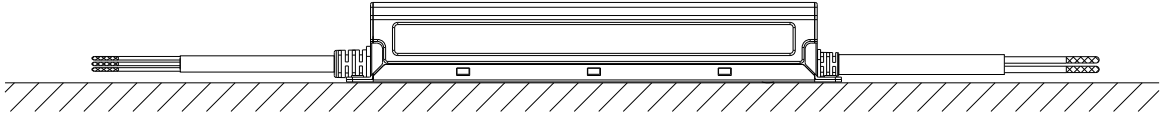

■ INSTALLATION MANUAL

Please refer to:<http://www.meanwell.com/manual.html>