



### Features

- Wide input range 180 ~ 528VAC
- Constant Voltage + Constant Current mode output
- Metal housing with Class I design
- Built-in active PFC function
- IP67 / IP65 rating for indoor or outdoor installations
- Function options: output adjustable via potentiometer; 3 in 1 dimming (dim-to-off) ; Smart timer dimming
- Typical lifetime>50000 hours
- 5 years warranty

### Applications

- LED street lighting
- LED high-bay lighting
- Parking space lighting
- LED fishing lamp
- LED greenhouse lighting
- Type “HL” for use in Class I , Division 2 hazardous (Classified) location.

### GTIN CODE

MW Search: <https://www.meanwell.com/serviceGTIN.aspx>

### Description

HVG-240 series is a 240W AC/DC LED power supply featuring the dual mode constant voltage and constant current output. HVG-240 operates from 180~528VAC and offers models with different rated voltage ranging between 24V and 54V. Thanks to the high efficiency up to 93%, with the fanless design, the entire series is able to operate for -40°C ~ +90°C case temperature under free air convection. The design of metal housing and IP67/IP65 ingress protection level allows this series to fit both indoor and outdoor applications. HVG-240 is equipped with various function options, such as dimming methodologies, so as to provide the optimal design flexibility for LED lighting system.

### Model Encoding

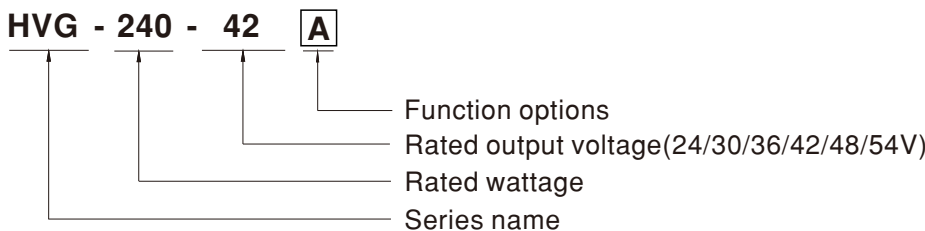

| Type | IP Level | Function   | Note       |
|------|----------|--|------------|
| A    | IP65     | Io and Vo adjustable through built-in potentiometer.   | In Stock   |
| B    | IP67     | 3 in 1 dimming function (0~10Vdc, 10V PWM signal and resistance)   | In Stock   |
| AB   | IP65     | Io and Vo adjustable through built-in potentiometer & 3 in 1 dimming function (0~10Vdc, 10V PWM signal and resistance) | In Stock   |
| Dx   | IP67     | Built-in Smart timer dimming function by user request.   | By request |
| D2   | IP67     | Built-in Smart timer dimming and programmable function.  | By request |

**SPECIFICATION**

| MODEL                   | HVG-240-24   | HVG-240-30  | HVG-240-36 | HVG-240-42   | HVG-240-48  | HVG-240-54   |             |
|-------------------------|--|---|------------|--------------|-------------|--------------|-------------|
| OUTPUT                  | DC VOLTAGE   | 24V   | 30V        | 36V          | 42V         | 48V          | 54V         |
|                         | CONSTANT CURRENT REGION Note.4   | 12 ~ 24V  | 15 ~ 30V   | 18 ~ 36V     | 21 ~ 42V    | 24 ~ 48V     | 27 ~ 54V    |
|                         | RATED CURRENT  | 10A   | 8A         | 6.7A         | 5.7A        | 5A           | 4.5A        |
|                         | RATED POWER  | 240W  | 240W       | 241.2W       | 239.4W      | 240W         | 243W        |
|                         | RIPPLE & NOISE (max.) Note.2   | 150mVp-p  | 200mVp-p   | 250mVp-p     | 250mVp-p    | 250mVp-p     | 350mVp-p    |
|                         | VOLTAGE ADJ. RANGE   | Adjustable for A/AB-Type only (via the built-in potentiometer)  |            |              |             |              |             |
|                         |  | 22.4 ~ 25.6V  | 28 ~ 32V   | 33.5 ~ 38.5V | 39 ~ 45V    | 44.8 ~ 51.2V | 50 ~ 57V    |
|                         | CURRENT ADJ. RANGE   | Adjustable for A/AB-Type only (via the built-in potentiometer)  |            |              |             |              |             |
|                         |  | 5 ~ 10A   | 4 ~ 8A     | 3.3 ~ 6.7A   | 2.85 ~ 5.7A | 2.5 ~ 5A     | 2.25 ~ 4.5A |
|                         | VOLTAGE TOLERANCE Note.3   | ±1.0%   | ±1.0%      | ±1.0%        | ±1.0%       | ±1.0%        | ±1.0%       |
|                         | LINE REGULATION  | ±0.5%   | ±0.5%      | ±0.5%        | ±0.5%       | ±0.5%        | ±0.5%       |
| LOAD REGULATION         | ±0.5%  | ±0.5%   | ±0.5%      | ±0.5%        | ±0.5%       | ±0.5%        |             |
| SETUP, RISE TIME Note.6 | 500ms, 150ms /230VAC, 347VAC, 480VAC   |   |            |              |             |              |             |
| HOLD UP TIME (Typ.)     | 12ms/347VAC, 480VAC  |   |            |              |             |              |             |
| INPUT                   | VOLTAGE RANGE Note.5   | 180 ~ 528VAC 254VDC ~ 747VDC<br>(Please refer to "STATIC CHARACTERISTIC" section)   |            |              |             |              |             |
|                         | FREQUENCY RANGE  | 47 ~ 63Hz   |            |              |             |              |             |
|                         | POWER FACTOR (Typ.)  | PF ≥ 0.98/230VAC, PF ≥ 0.97/277VAC, PF ≥ 0.95/347VAC, PF ≥ 0.93/480VAC @full load<br>(Please refer to "POWER FACTOR (PF) CHARACTERISTIC" section) |            |              |             |              |             |
|                         | TOTAL HARMONIC DISTORTION  | THD < 20% (@ load ≥ 50%/230VAC, 277VAC, 347VAC, @ load ≥ 60%/480VAC)<br>(Please refer to "TOTAL HARMONIC DISTORTION (THD)" section)               |            |              |             |              |             |
|                         | EFFICIENCY (Typ.)  | 92.5%   | 92.5%      | 93%          | 93%         | 92.5%        | 93%         |
|                         | AC CURRENT (Typ.)  | 0.8A / 347VAC 0.6A / 480VAC   |            |              |             |              |             |
|                         | INRUSH CURRENT(Typ.)   | COLD START 50A(twidth=532μs measured at 50% Ipeak) at 480VAC; Per NEMA 410  |            |              |             |              |             |
|                         | MAX. NO. of PSUs on 16A CIRCUIT BREAKER  | 4unit(circuit breaker of type B) / 6units(circuit breaker of type C) at 480VAC  |            |              |             |              |             |
| LEAKAGE CURRENT         | <0.75mA / 480VAC   |   |            |              |             |              |             |
| PROTECTION              | OVER CURRENT   | 95 ~ 108%<br>Constant current limiting, recovers automatically after fault condition is removed   |            |              |             |              |             |
|                         | SHORT CIRCUIT  | Constant current limiting, recovers automatically after fault condition is removed  |            |              |             |              |             |
|                         | OVER VOLTAGE   | 27 ~ 34V  | 33 ~ 39V   | 43 ~ 49V     | 48 ~ 54V    | 55 ~ 63V     | 60 ~ 67V    |
|                         | OVER TEMPERATURE   | Shut down and latch off o/p voltage, re-power on to recover   |            |              |             |              |             |
| ENVIRONMENT             | WORKING TEMP.  | Tcase=-40 ~ +90°C (Please refer to "OUTPUT LOAD vs TEMPERATURE" section)  |            |              |             |              |             |
|                         | MAX. CASE TEMP.  | Tcase=+90°C   |            |              |             |              |             |
|                         | WORKING HUMIDITY   | 20 ~ 95% RH non-condensing  |            |              |             |              |             |
|                         | STORAGE TEMP., HUMIDITY  | -40 ~ +85°C, 10 ~ 95% RH non-condensing   |            |              |             |              |             |
|                         | TEMP. COEFFICIENT  | ±0.03%/°C (0 ~ 60°C)  |            |              |             |              |             |
| SAFETY & EMC            | VIBRATION  | 10 ~ 500Hz, 5G 12min./1cycle, period for 72min. each along X, Y, Z axes   |            |              |             |              |             |
|                         | SAFETY STANDARDS   | UL8750 (type"HL"), CSA C22.2 No. 250.13-12, EAC TP TC 004, IP65 or IP67 approved  |            |              |             |              |             |
|                         | WITHSTAND VOLTAGE  | I/P-O/P:3.75KVAC I/P-FG:2KVAC O/P-FG:1.5KVAC  |            |              |             |              |             |
|                         | ISOLATION RESISTANCE   | I/P-O/P, I/P-FG, O/P-FG:100M Ohms / 500VDC / 25°C / 70% RH  |            |              |             |              |             |
|                         | EMC EMISSION   | Compliance to FCC Part 15 Subpart B,EAC TP TC 020   |            |              |             |              |             |
| OTHERS                  | EMC IMMUNITY   | Compliance to EN61000-4-2,3,4,5,6,8,11, EN61547, light industry level (surge immunity Line-Earth 4KV, Line-Line 2KV), EAC TP TC 020               |            |              |             |              |             |
|                         | MTBF   | 1704.5K hrs min. Telcordia SR-332(Bellcore) ; 141.9K hrs min. MIL-HDBK-217F (25°C)  |            |              |             |              |             |
| DIMENSION               | 254.2*68*38.8mm (L*W*H)  |   |            |              |             |              |             |
|                         | PACKING 1.31Kg; 12pcs/15.7Kg/0.78CUFT  |   |            |              |             |              |             |
| NOTE                    | <ol style="list-style-type: none"> <li>All parameters NOT specially mentioned are measured at 347VAC input, rated load and 25°C of ambient temperature.</li> <li>Ripple &amp; noise are measured at 20MHz of bandwidth by using a 12" twisted pair-wire terminated with a 0.1uf &amp; 47uf parallel capacitor.</li> <li>Tolerance : includes set up tolerance, line regulation and load regulation.</li> <li>Please refer to "DRIVING METHODS OF LED MODULE".</li> <li>De-rating may be needed under low input voltages. Please refer to "STATIC CHARACTERISTIC" sections for details.</li> <li>Length of set up time is measured at first cold start. Turning ON/OFF the power supply may lead to increase of the set up time.</li> <li>The driver is considered as a component that will be operated in combination with final equipment. Since EMC performance will be affected by the complete installation, the final equipment manufacturers must re-qualify EMC Directive on the complete installation again.<br/>(as available on <a href="https://www.meanwell.com/Upload/PDF/EMI_statement_en.pdf">https://www.meanwell.com/Upload/PDF/EMI_statement_en.pdf</a>)</li> <li>This series meets the typical life expectancy of &gt;50,000 hours of operation when Tcase, particularly (tc) point (or TMP, per DLC), is about 80°C or less.</li> <li>Please refer to the warranty statement on MEAN WELL's website at <a href="http://www.meanwell.com">http://www.meanwell.com</a>.</li> <li>The ambient temperature derating of 3.5°C/1000m with fanless models and of 5°C/1000m with fan models for operating altitude higher than 2000m(6500ft).</li> <li>For any application note and IP water proof function installation caution, please refer our user manual before using.<br/><a href="https://www.meanwell.com/Upload/PDF/LED_EN.pdf">https://www.meanwell.com/Upload/PDF/LED_EN.pdf</a></li> <li>For A/AB type need to consider build in using to comply with Type HL application.</li> </ol> <p>※ Product Liability Disclaimer : For detailed information, please refer to <a href="https://www.meanwell.com/serviceDisclaimer.aspx">https://www.meanwell.com/serviceDisclaimer.aspx</a></p> |   |            |              |             |              |             |

### Block Diagram

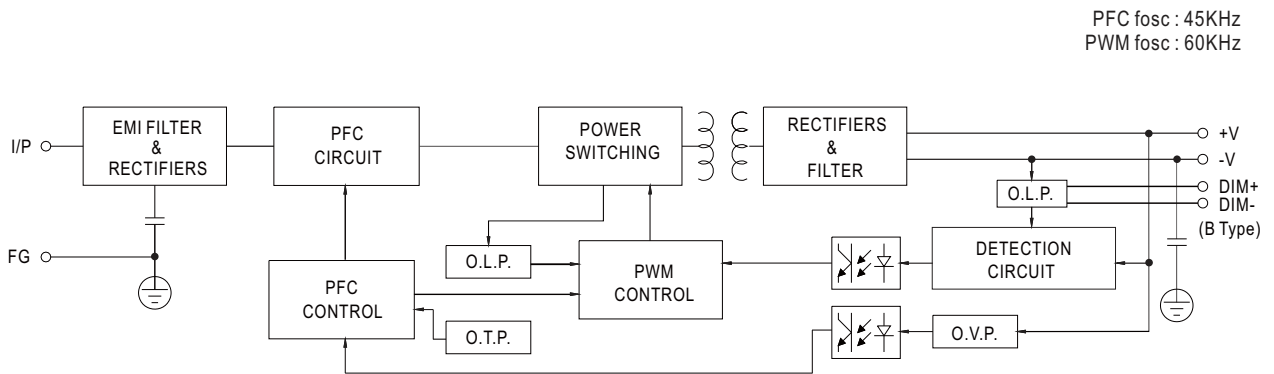

### DRIVING METHODS OF LED MODULE

※ This series is able to work in either Constant Current mode (a direct drive way) or Constant Voltage mode (usually through additional DC/DC driver) to drive the LEDs.

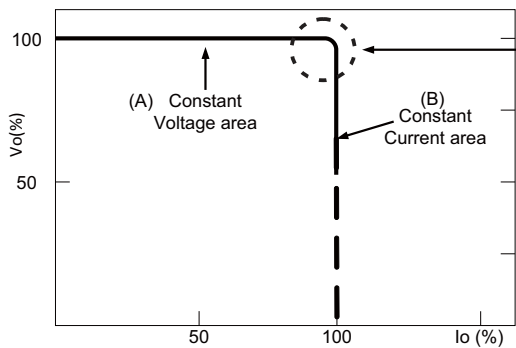

Typical output current normalized by rated current (%)

In the constant current region, the highest voltage at the output of the driver depends on the configuration of the end systems.

Should there be any compatibility issues, please contact MEAN WELL.

## ■ DIMMING OPERATION

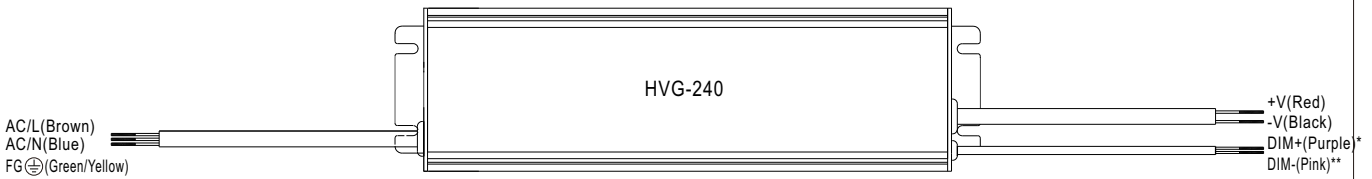

### ※ 3 in 1 dimming function (for B/AB-Type)

- Output constant current level can be adjusted by applying one of the three methodologies between DIM+ and DIM-: 0 ~ 10VDC, or 10V PWM signal or resistance.
- Direct connecting to LEDs is suggested. It is not suitable to be used with additional drivers.
- Dimming source current from power supply: 100 $\mu$ A (typ.)

\* DIM+ for B/AB-Type  
 PROG+ for D2-Type  
 \*\* DIM- for B/AB-Type  
 PROG- for D2-Type

#### ◎ Applying additive 0 ~ 10VDC

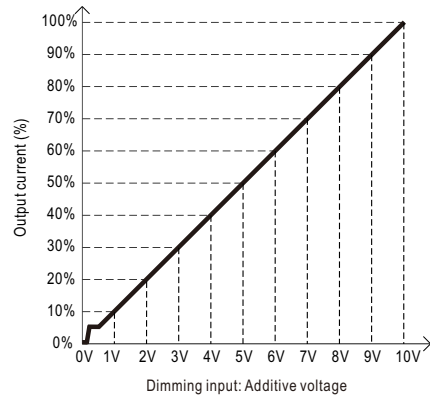
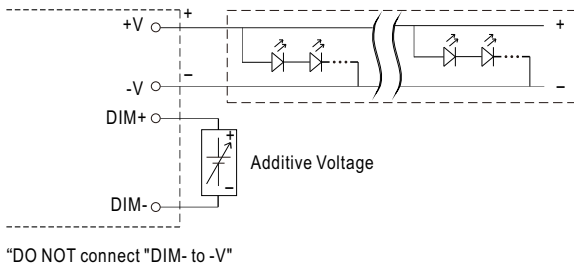

#### ◎ Applying additive 10V PWM signal (frequency range 100Hz ~ 3KHz):

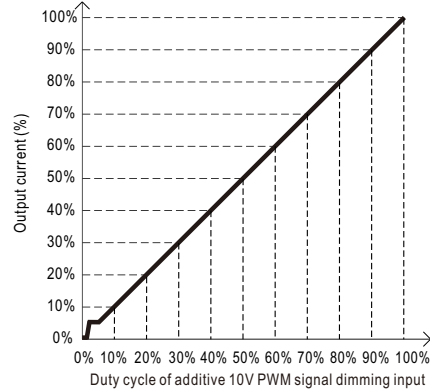
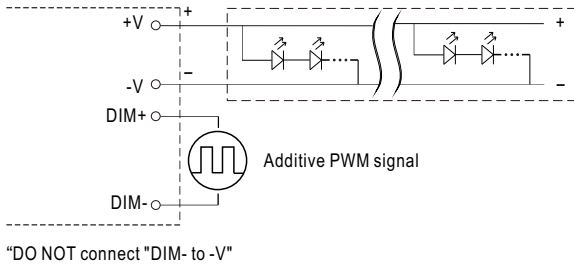

#### ◎ Applying additive resistance:

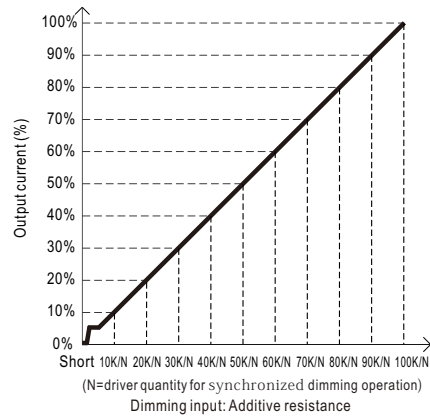
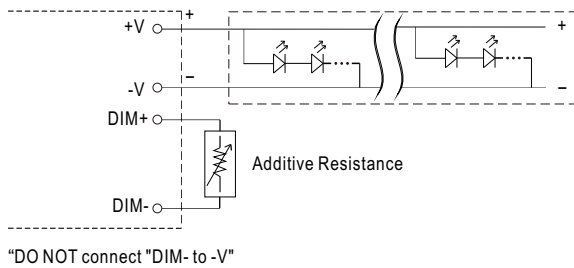

Note : 1. Min. dimming level is about 5% and the output current is not defined when 0% < I<sub>out</sub> < 5%.  
 2. The output current could drop down to 0% when dimming input is about 0k $\Omega$  or 0Vdc, or 10V PWM signal with 0% duty cycle.

※ **Smart timer dimming function (for Dxx-Type by User definition)**

MEAN WELL Smart timer dimming primarily provides the adaptive proportion dimming profile for the output constant current level to perform up to 14 consecutive hours. 3 dimming profiles hereunder are defined accounting for the most frequently seen applications. If other options may be needed, please contact MEAN WELL for details.

Ex : ☉ D01-Type: the profile recommended for residential lighting

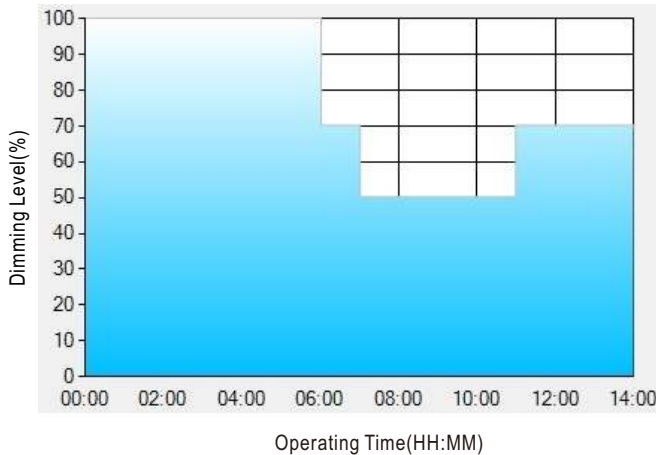

Set up for D01-Type in Smart timer dimming software program:

|         | T1    | T2    | T3    | T4  |
|---------|-------|-------|-------|-----|
| TIME**  | 06:00 | 07:00 | 11:00 | --- |
| LEVEL** | 100%  | 70%   | 50%   | 70% |

\*\* : TIME matches Operating Time in the diagram whereas LEVEL matches Dimming Level.

Example: If a residential lighting application adopts D01-Type, when turning on the power supply at 6:00pm, for instance:

- [1] The power supply will switch to the constant current level at 100% starting from 6:00pm.
  - [2] The power supply will switch to the constant current level at 70% in turn, starting from 0:00am, which is 06:00 after the power supply turns on.
  - [3] The power supply will switch to the constant current level at 50% in turn, starting from 1:00am, which is 07:00 after the power supply turns on.
  - [4] The power supply will switch to the constant current level at 70% in turn, starting from 5:00am, which is 11:00 after the power supply turns on.
- The constant current level remains till 8:00am, which is 14:00 after the power supply turns on.

Ex : ☉ D02-Type: the profile recommended for street lighting

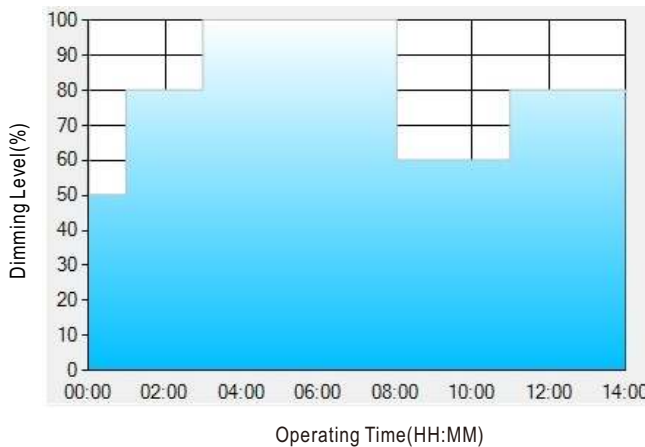

Set up for D02-Type in Smart timer dimming software program:

|         | T1    | T2    | T3   | T4    | T5  |
|---------|-------|-------|------|-------|-----|
| TIME**  | 01:00 | 03:00 | 8:00 | 11:00 | --- |
| LEVEL** | 50%   | 80%   | 100% | 60%   | 80% |

\*\* : TIME matches Operating Time in the diagram whereas LEVEL matches Dimming Level.

Example: If a street lighting application adopts D02-Type, when turning on the power supply at 5:00pm, for instance:

- [1] The power supply will switch to the constant current level at 50% starting from 5:00pm.
- [2] The power supply will switch to the constant current level at 80% in turn, starting from 6:00pm, which is 01:00 after the power supply turns on.
- [3] The power supply will switch to the constant current level at 100% in turn, starting from 8:00pm, which is 03:00 after the power supply turns on.
- [4] The power supply will switch to the constant current level at 60% in turn, starting from 1:00am, which is 08:00 after the power supply turns on.
- [5] The power supply will switch to the constant current level at 80% in turn, starting from 4:00am, which is 11:00 after the power supply turns on. The constant current level remains till 6:30am, which is 14:00 after the power supply turns on.

Ex: © D03-Type: the profile recommended for tunnel lighting

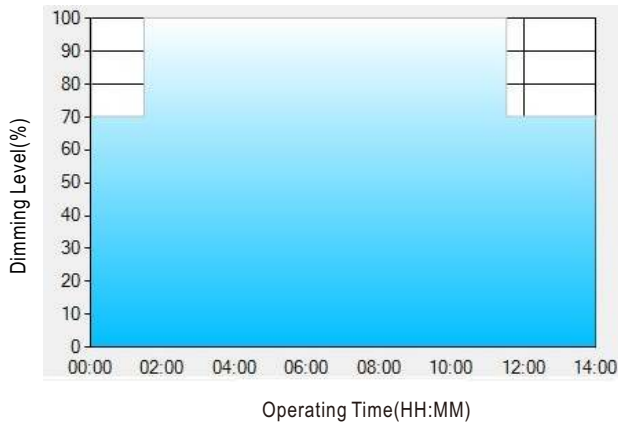

Set up for D03-Type in Smart timer dimming software program:

|         | T1    | T2    | T3  |
|---------|-------|-------|-----|
| TIME**  | 01:30 | 11:00 | --- |
| LEVEL** | 70%   | 100%  | 70% |

\*\* : TIME matches Operating Time in the diagram whereas LEVEL matches Dimming Level.

Example: If a tunnel lighting application adopts D03-Type, when turning on the power supply at 4:30pm, for instance:

[1] The power supply will switch to the constant current level at 70% starting from 4:30pm.

[2] The power supply will switch to the constant current level at 100% in turn, starting from 6:00pm, which is 01:30 after the power supply turns on.

[3] The power supply will switch to the constant current level at 70% in turn, starting from 5:00am, which is 11:00 after the power supply turns on.

The constant current level remains till 6:30am, which is 14:00 after the power supply turns on.

### OUTPUT LOAD vs TEMPERATURE(Notes.9)

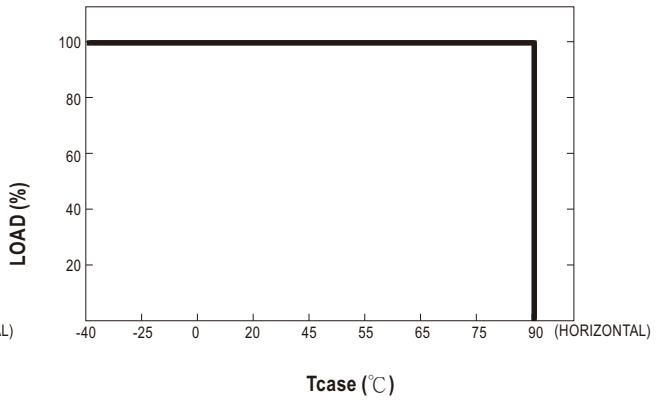
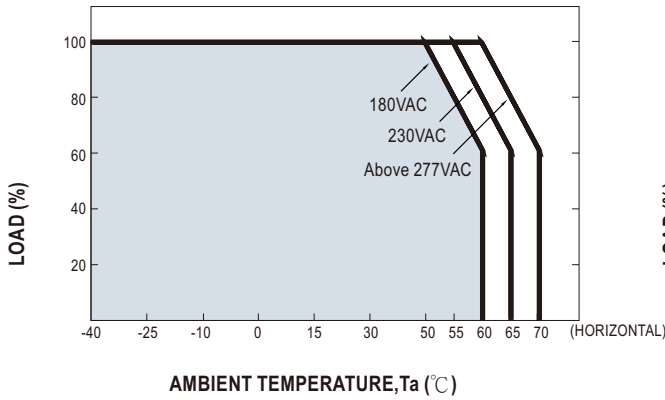



■ LIFE TIME

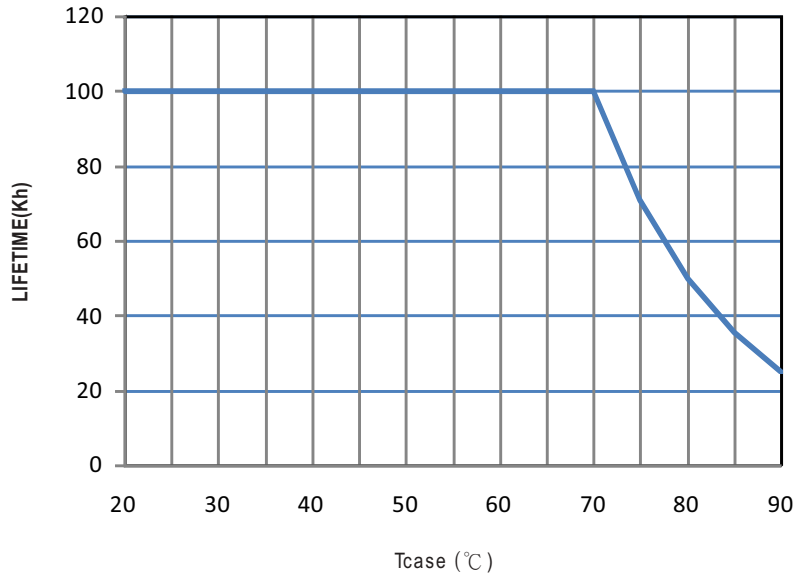



MECHANICAL SPECIFICATION

Case No. 994

Unit:mm

Tolerance:±1

※ A-Type

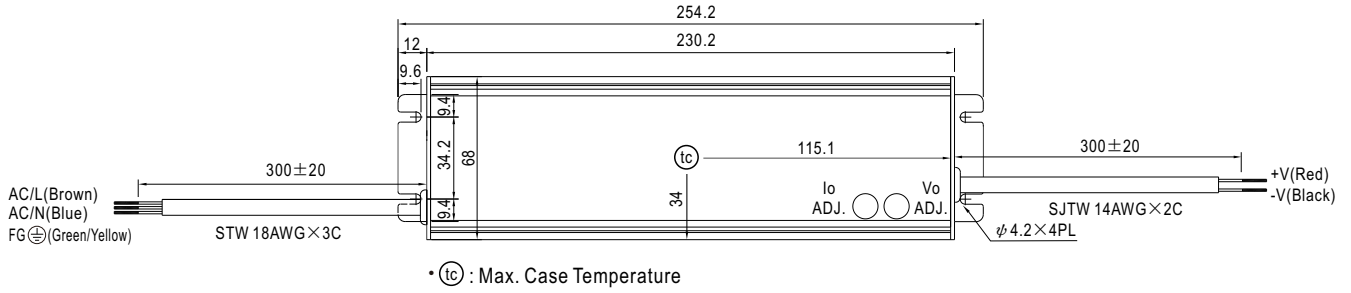

※ AB-Type

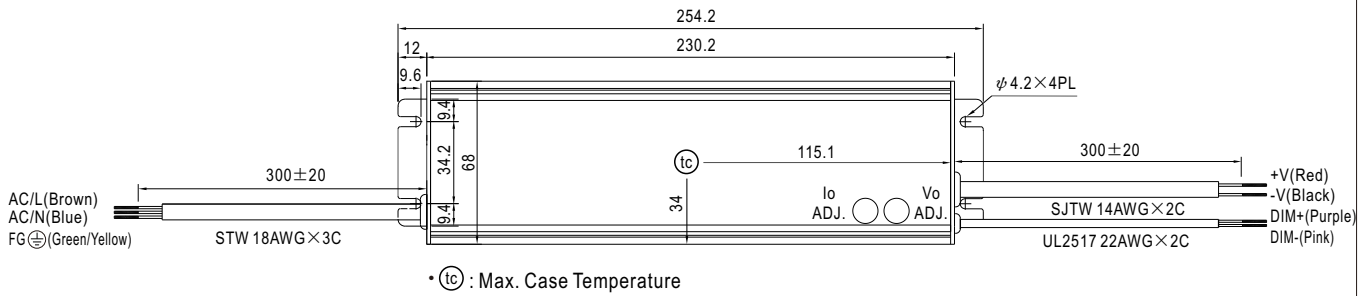



※ B/D2-Type

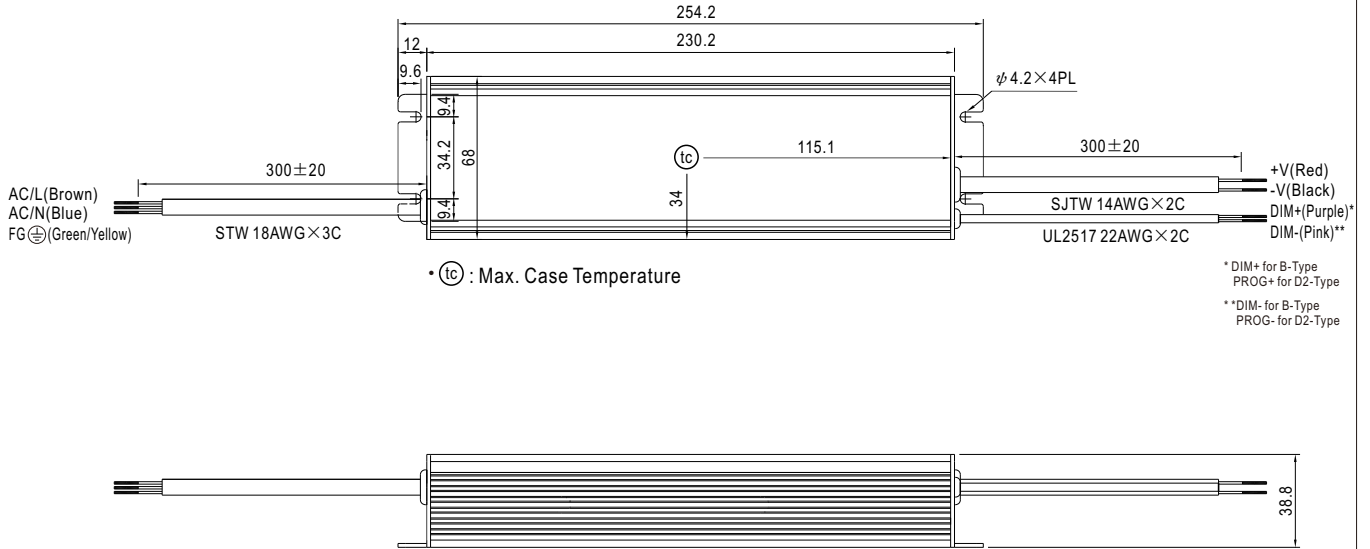

\* DIM+ for B-Type  
PROG+ for D2-Type  
\*\* DIM- for B-Type  
PROG- for D2-Type

## ■ INSTALLATION MANUAL

Please refer to : <http://www.meanwell.com/manual.html>