

## Features

- 90~264Vac universal AC input, built-in PFC
- Charger for compatible with lead-acid and li-ion batteries
- **Wide adjustable output range by VR:**
  - ▶ Charging voltage adjustable(10.5~15.2V, 21~30.4V, 42~60.8V)
  - ▶ Charging current adjustable(50~100% rated current)
- 2 or 3 stage selectable by DIP S.W
- No load power consumption< 0.15W(AC S.W off)
- Fan ON-OFF control (Depends on internal temperature)
- -30°C~+70°C wide operating temperature
- Protections: Short circuit / Over voltage /Over temperature / Battery reverse polarity protection
- Comply with UL/EN62368-1 and EN60335-1/2-29 **dual certification**
- Front panel LED indicator for charging status
- 3 years warranty

## Applications

- Radio system backup solution
- Electric scooter charger
- Camping car 、 Buses 、 Heavy duty truck 、 Specialty vehicles
- Surveillance system
- Portable power tools

## GTIN CODE

MW Search : <https://www.meanwell.com/serviceGTIN.aspx>

## Description

NPB-360 series is a 360W charger for compatible with lead-acid (Flooded, Gel, AGM) and li-ion(Lithium iron, lithium manganese) batteries. This product is a class I power unit (with FG), equipped with a standard IEC320-C14 AC inlet and two or three-stage charging control. The entire series supplies different models with output voltages ranging between 10.5VDC and 60.8VDC that can satisfy the demands for various types of batteries devices.

## Model Encoding

NPB - 360 - 24 XLR

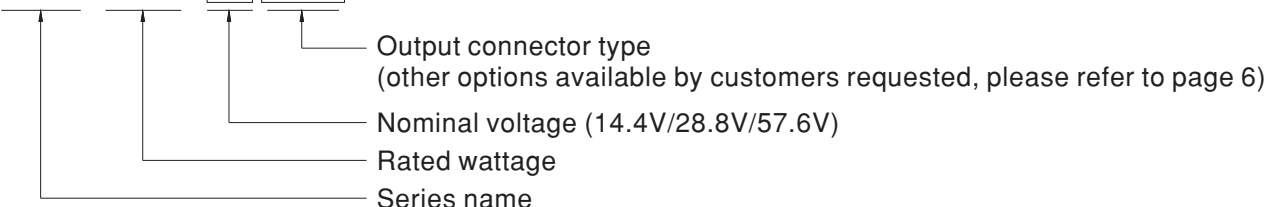

Type	Output Connector	Safety	Note
XLR	4 pin power pin		In Stock
AD1	Anderson Equivalent Connector	(48V UL certificated same as TB Type)	In Stock
TB	Terminal Block		In Stock

**SPECIFICATION**

MODEL		NPB-360-12□	NPB-360-24□	NPB-360-48□	
□ =XLR, AD1, TB					
OUTPUT	BOOST CHARGE VOLTAGE(Vboost)(default)	14.4V	28.8V	57.6V	
	FLOAT CHARGE VOLTAGE(Vfloat)(default)	13.8V	27.6V	55.2V	
	VOLTAGE ADJUSTABLE RANGE	10.5 ~ 15.2V	21 ~ 30.4V	42 ~ 60.8V	
	OUTPUT CURRENT(Typ.) Note.5	20A	12A	6A	
	CURRENT ADJUSTABLE RANGE	50% ~ 100%			
	MAX. POWER Note.3	304W	364.8W	364.8W	
	RECOMMENDED BATTERY CAPACITY (AMP HOURS) Note.4	65 ~ 195AH	40 ~ 125AH	20 ~ 65AH	
LEAKAGE CURRENT FROM BATTERY (Typ.)	<1mA				
INPUT	VOLTAGE RANGE Note.5	90 ~ 264VAC 127 ~ 370VDC			
	FREQUENCY RANGE	47 ~ 63Hz			
	POWER FACTOR (Typ.)	PF>0.98/115VAC, PF>0.95/230VAC at full load			
	EFFICIENCY (Typ.)	XLR	87%	91%	92%
		AD1	87%	91%	92%
		TB	88.5%	92%	92.5%
	AC CURRENT (Typ.)	4.5A/115VAC 2.2A/230VAC			
INRUSH CURRENT (Typ.)	COLD START 50A at 230VAC				
LEAKAGE CURRENT	<0.75mA/240VAC				
PROTECTION	SHORT CIRCUIT Note.6	Protection type : Constant current limiting, charger will shutdown after 5 sec, re-power on to recover			
	OVER VOLTAGE	16 ~ 20V	32 ~ 40V	64 ~ 75V	
	REVERSE POLARITY	By internal fuse open			
	OVER TEMPERATURE	Hiccup mode, recovers automatically after temperature goes down			
FUNCTION	CHARGING CURVE	2 or 3 stage adjustable by DIP S.W			
	FAN CONTROL (Typ.)	Internal RTH3 ≥ 50°C Fan ON, ≤ 45°C Fan OFF			
ENVIRONMENT	WORKING TEMP.	-30 ~ +70°C (Refer to "Derating Curve")			
	WORKING HUMIDITY	20 ~ 95% RH non-condensing			
	STORAGE TEMP., HUMIDITY	-40 ~ +85°C, 10 ~ 95% RH non-condensing			
	TEMP. COEFFICIENT	±0.05%/°C (0 ~ 45°C)			
	VIBRATION	10 ~ 500Hz, 2G 10min./1 cycle, 60min. each along X, Y, Z axes			
SAFETY & EMC (Note 7)	SAFETY STANDARDS	CB IEC62368-1,IEC60335-1/2-29, Dekra BS EN/EN62368-1,BS EN/EN60335-1/2-29, UL62368-1, AS/NZS60335-1/2-29, J62368-1(2020) (except for 48XLR & TB type) ,KC62368-1,EAC TP TC 004 approved			
	WITHSTAND VOLTAGE	I/P-O/P:3KVAC I/P-FG:2KVAC O/P-FG:0.5KVAC			
	ISOLATION RESISTANCE	I/P-O/P, I/P-FG, O/P-FG:100M Ohms / 500VDC / 25°C / 70% RH			
	EMC EMISSION	Parameter	Standard	Test Level / Note	
		Conducted	BS EN/EN55032 (CISPR32),BS EN/EN55014-1	Class B	
		Radiated	BS EN/EN55032 (CISPR32),BS EN/EN55014-1	Class B	
		Harmonic Current	BS EN/EN61000-3-2	Class A	
	Voltage Flicker	BS EN/EN61000-3-3	-----		
	EMC IMMUNITY	Parameter	Standard	Test Level / Note	
		ESD	BS EN/EN61000-4-2	Level 3, 8KV air ; Level 2, 4KV contact	
Radiated		BS EN/EN61000-4-3	Level 2, 3V/m		
EFT / Burst		BS EN/EN61000-4-4	Level 2, 1KV		
Surge		BS EN/EN61000-4-5	Level 2, 1KV/Line-Line,Level 3, 2KV/Line-Earth		
Conducted		BS EN/EN61000-4-6	Level 2, 3Vrms		
Magnetic Field		BS EN/EN61000-4-8	Level 1, 1A/m		
Voltage Dips and Interruptions		BS EN/EN61000-4-11	>95% dip 0.5 periods, 30% dip 25 periods, >95% interruptions 250 periods		
OTHERS	MTBF	1324.7K hrs min. Telcordia TR/SR-332 (Bellcore) ; 173.9K hrs min. MIL-HDBK-217F (25°C)			
	DIMENSION	182.7*96*49mm (L*W*H)			
	PACKING	1.3Kg; 10pcs/ 14Kg / 1.13CUFT			
NOTE	<p>1. Modification for charger specification may be required for different battery specification. Please contact battery vendor and MEAN WELL for details.</p> <p>2. All parameters NOT specially mentioned are measured at 230VAC input, rated load and 25°C of ambient temperature.</p> <p>3. Refer to derating curve.</p> <p>4. This is MEAN WELL's suggested range. Please consult your battery manufacturer for their suggestions about maximum charging current limitation.</p> <p>5. Derating may be needed under low input voltages. Please check the derating curve for more details.</p> <p>6. This protection mechanism is specified for the case the short circuit occurs after the charger is turned on.</p> <p>7. The charger is considered a component which will be installed into a final equipment. The final equipment must be re-confirmed that it still meets EMC directives. For guidance on how to perform these EMC tests, please refer to "EMI testing of component power supplies." (as available on <a href="https://www.meanwell.com/Upload/PDF/EMI_statement_en.pdf">https://www.meanwell.com/Upload/PDF/EMI_statement_en.pdf</a>)</p> <p>※ Product Liability Disclaimer : For detailed information, please refer to <a href="https://www.meanwell.com/serviceDisclaimer.aspx">https://www.meanwell.com/serviceDisclaimer.aspx</a></p>				

### Block Diagram

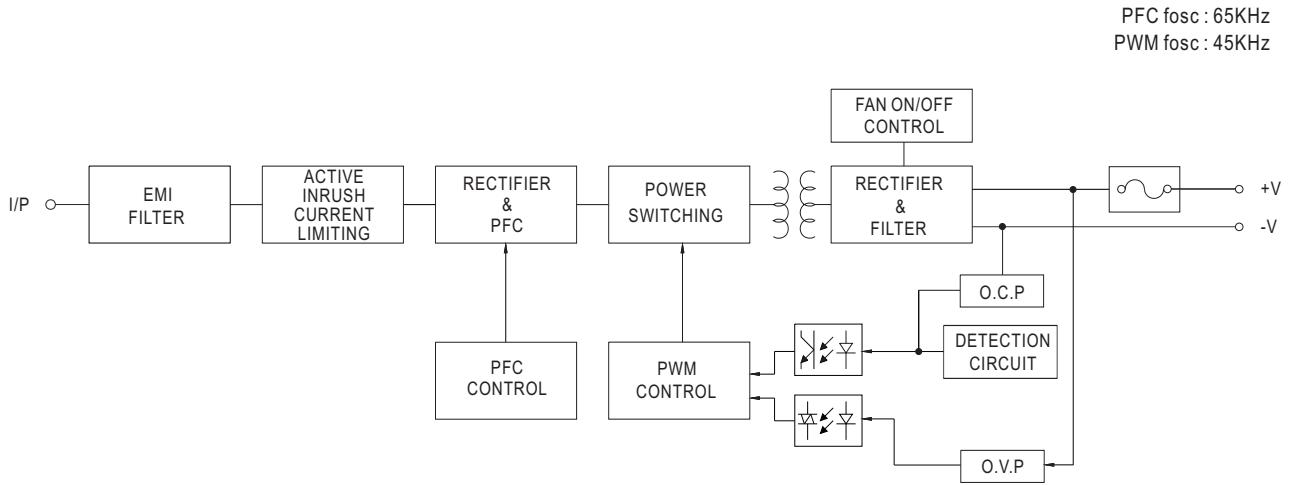

### Derating Curve

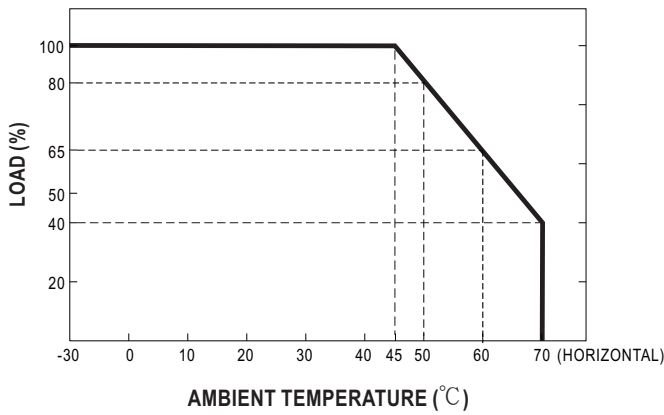

### Static Characteristics

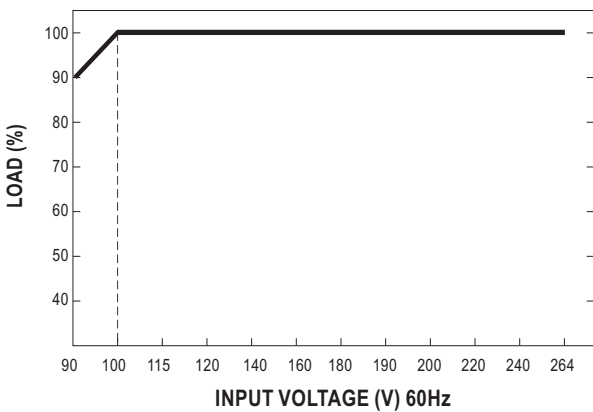

## Function Manual

### 1. Charging Curve

#### 1-1 2 or 3 stage selectable by DIP S.W

※ This series provides 2 or 3 stage charging curve. (Default 3 stage)

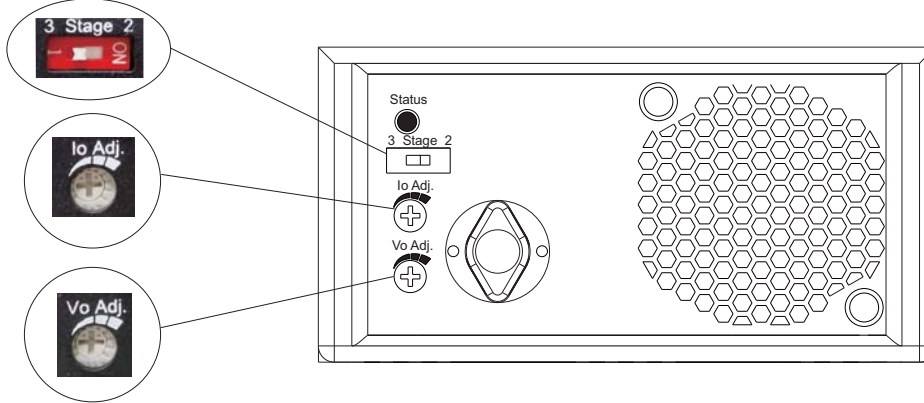

#### 1-2 Charging Curve by DIP S.W

##### ⊙ 2 stage charging curve

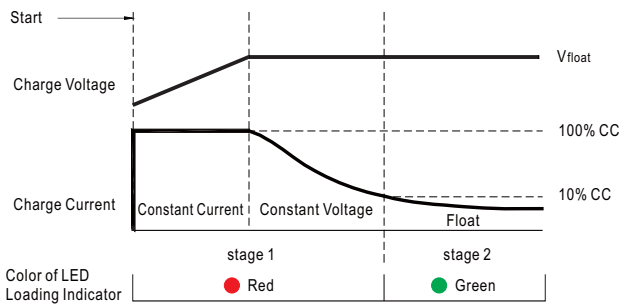

State	NPB-360-12	NPB-360-24	NPB-360-48
Constant Current	20A	12A	6A
V <sub>float</sub>	13.8V	27.6V	55.2V

##### ⊙ 3 stage charging curve

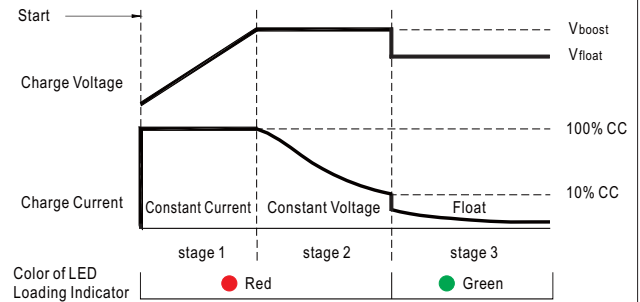

State	NPB-360-12	NPB-360-24	NPB-360-48
Constant Current	20A	12A	6A
V <sub>boost</sub>	14.4V	28.8V	57.6V
V <sub>float</sub>	13.8V	27.6V	55.2V

⊙ 2 stage charging cure is suitable for Li-ion batteries (lithium iron and lithium manganese),

3 stage charging cure is suitable for lead-acid batteries (flooded, Gel and AGM).

### 2. Charging voltage adjustable by VR

Model	NPB-360-12 <input type="checkbox"/>	NPB-360-24 <input type="checkbox"/>	NPB-360-48 <input type="checkbox"/>
Output voltage adjustable range	10.5~15.2V	21~30.4V	42~60.8V



### 3. Charging current adjustable by VR

Model	NPB-360-12 <input type="checkbox"/>	NPB-360-24 <input type="checkbox"/>	NPB-360-48 <input type="checkbox"/>
Output current adjustable range	10~20A	6~12A	3~6A



### 4. Front panel LED indicators & Corresponding signal at function pins

LED	Description
● Green	Float (stage 3) or Battery full
● Red	Charging (stage 1 or stage 2)



## ■ Mechanical Specification

(Unit: mm , tolerance  $\pm 1$ mm)

Case No.PS-120F

- ◎ NPB-360-xx XLR/AD1  
(Cable Type)

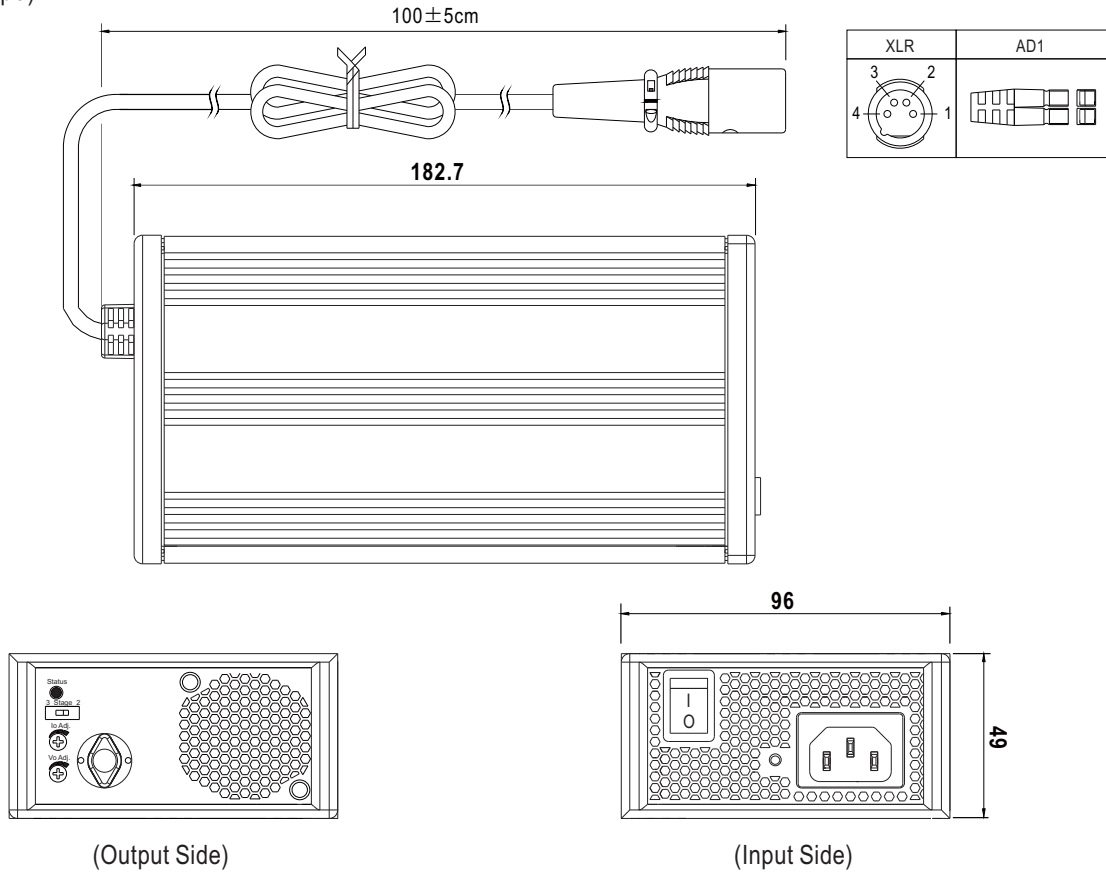

- ◎ NPB-360-xx TB  
(Terminal Block Type)

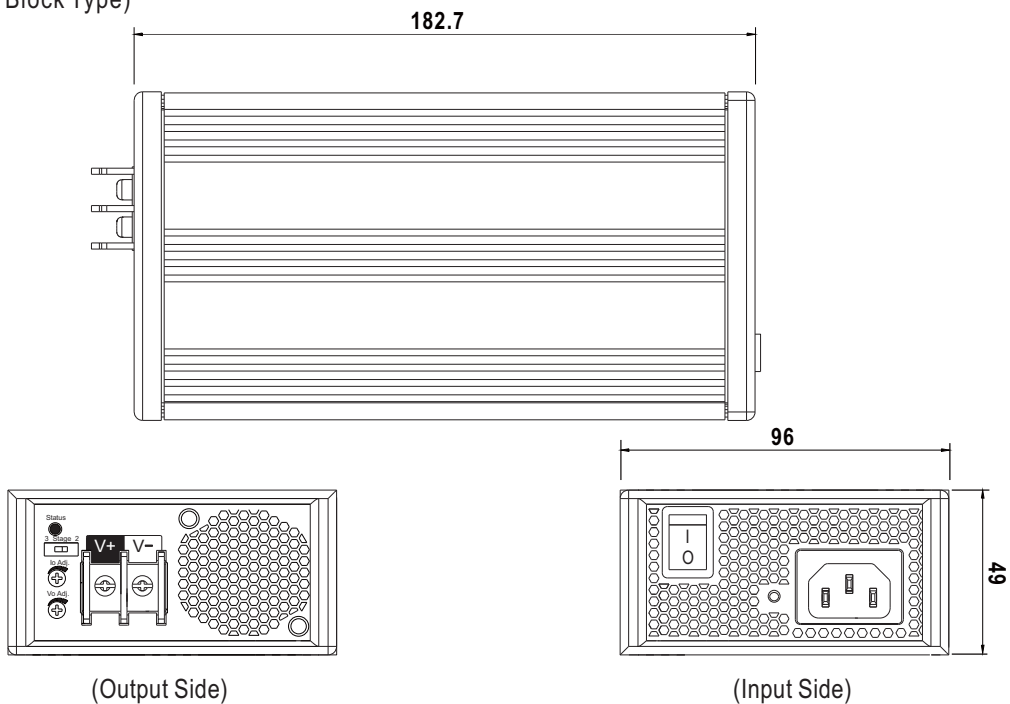

■ **Accessory List**

※ Bracket (Optional accessory, Should ordered separately)

MW's Order No.	Item	Quantity
PGG2MHS012D		4pcs/per model

■ **Installation Diagram**

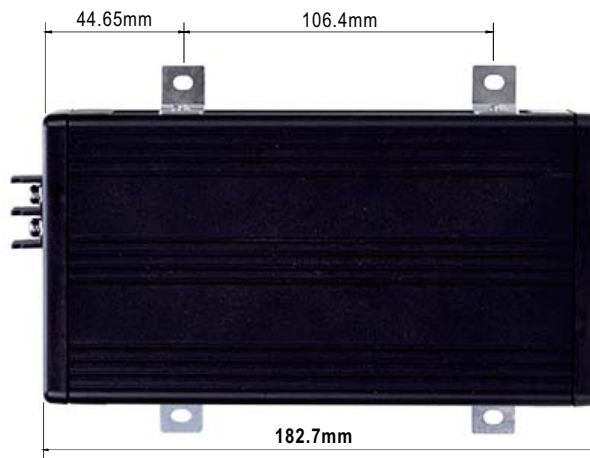
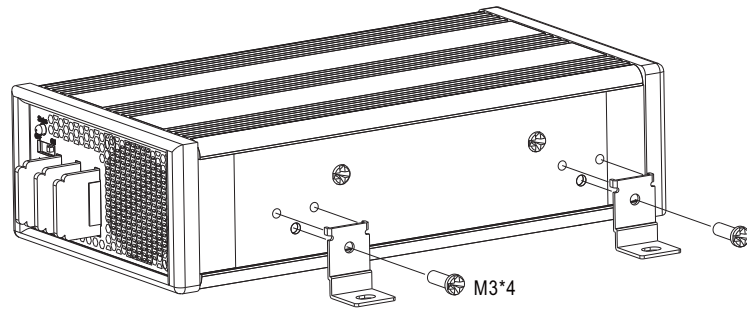

**Plug Assignment**



☉ Standard Output Connector

**4pin XLR**  
UNICABLE 89M103-4P or equivalent

		PIN NO.	OUTPUT
3	2	1,2	+V
4	1	3,4	-V





**AD1**  
housing: Anderson 1327(red), 1327G6(black) equivalent  
contacts: Anderson 261G2 (45A) equivalent

Red(+V)  Black(-V) 











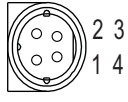
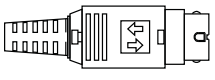

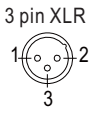
**TB**  
DT-66-B11W-02 or equivalent  
Rating: 300V 40A

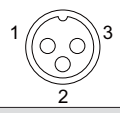
+V  -V 

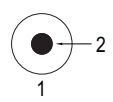
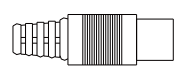

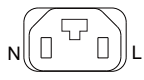
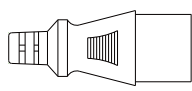
☉ Optional DC plug: (Available in customized)

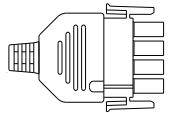
Min. DIN 4 Pin with Lock (male)	Type No.	Pin Assignment	
		PIN No.	Output(<7A)
   <p>KYCON KPPX-4P equivalent</p>	R7B	1	+Vo
		2	-Vo
		3	-Vo
		4	+Vo
DIN 3 Pin XLR	Type No.	Pin Assignment	
  	XLR3	1	+Vo
		2	+Vo
		3	-Vo
DIN 3 Pin	Type No.	Pin Assignment	
  	D3P	1	+Vo
		2	-Vo
		3	-Vo
DIN 2 Pin	Type No.	Pin Assignment	
  	D2P	1	-Vo
		2	+Vo
DIN 3 Pin	Type No.	Pin Assignment	
  	INL3	N	+Vo
		L	-Vo
AMP 1-480702-0 (6.35mm) equivalent	Type No.	Pin Assignment	
   <p>FG not connected to output connector</p>	C4P	1	+Vo
		2	+Vo
		3	-Vo
		4	-Vo

**INSTALLATION MANUAL**

Please refer to : <http://www.meanwell.com/manual.html>